



CIX40 Voice Processing System

User Guide

Publication Information

Toshiba America Information Systems, Inc., Telecommunication Systems Division, reserves the right, without prior notice, to revise this information publication for any reason, including, but not limited to, utilization of new advances in the state of technical arts or to simply change the design of this document.

Further, Toshiba America Information Systems, Inc., Telecommunication Systems Division, also reserves the right, without prior notice, to make such changes in equipment design or components as engineering or manufacturing methods may warrant.

CIX-UG-GVPH-VA

Version A, July 2006

© Copyright 2006

Toshiba America Information Systems, Inc. Telecommunication Systems Division

All rights reserved. No part of this manual, covered by the copyrights hereon, may be reproduced in any form or by any means—graphic, electronic, or mechanical, including recording, taping, photocopying, or information retrieval systems—without express written permission of the publisher of this material.

Strata is a registered trademark of Toshiba Corporation.

Strategy and Perception are registered trademarks of Toshiba America Information Systems, Inc.

Trademarks, registered trademarks, and service marks are the property of their respective owners.

TOSHIBA AMERICA INFORMATION SYSTEMS, INC. ("TAIS")

Telecommunication Systems Division License Agreement

IMPORTANT: THIS LICENSE AGREEMENT ("AGREEMENT") IS A LEGAL AGREEMENT BETWEEN YOU ("YOU") AND TAIS. CAREFULLY READ THIS LICENSE AGREEMENT. USE OF ANY SOFTWARE OR ANY RELATED INFORMATION (COLLECTIVELY, "SOFTWARE") INSTALLED ON OR SHIPPED WITH A TAIS TELECOMMUNICATION SYSTEMS PRODUCT OR OTHERWISE MADE AVAILABLE TO YOU BY TAIS IN WHATEVER FORM OR MEDIA, WILL CONSTITUTE YOUR ACCEPTANCE OF THESE TERMS, UNLESS SEPARATE TERMS ARE PROVIDED BY THE SOFTWARE SUPPLIER. IF YOU DO NOT AGREE WITH THE TERMS OF THIS LICENSE AGREEMENT, DO NOT INSTALL, COPY OR USE THE SOFTWARE AND PROMPTLY RETURN IT TO THE LOCATION FROM WHICH YOU OBTAINED IT IN ACCORDANCE WITH APPLICABLE RETURN POLICIES, EXCEPT AS OTHERWISE AUTHORIZED IN WRITING BY TAIS. THIS SOFTWARE IS LICENSED FOR DISTRIBUTION THROUGH TAIS AUTHORIZED CHANNELS ONLY TO END-USERS PURSUANT TO THIS LICENSE AGREEMENT.

1. **License Grant.** The Software is not sold; it is licensed upon payment of applicable charges. TAIS grants to you a personal, non-transferable and non-exclusive right to use the copy of the Software provided under this License Agreement. You agree you will not copy the Software except as necessary to use it on one TAIS system at a time at one location. Modifying, translating, renting, copying, distributing, printing, sublicensing, transferring or assigning all or part of the Software, or any rights granted hereunder, to any other persons and removing any proprietary notices, labels or marks from the Software is strictly prohibited except as permitted by applicable law; you agree violation of such restrictions will cause irreparable harm to TAIS and provide grounds for injunctive relief, without notice, against you or any other person in possession of the Software. You and any other person whose possession of the software violates this License Agreement shall promptly surrender possession of the Software to TAIS, upon demand. Furthermore, you hereby agree not to create derivative works based on the Software. TAIS reserves the right to terminate this license and to immediately repossess the software in the event that you or any other person violates this License Agreement. Execution of the Software for any additional capabilities require a valid run-time license.
2. **Intellectual Property.** You acknowledge that no title to the intellectual property in the Software is transferred to you. You further acknowledge that title and full ownership rights to the Software will remain the exclusive property of TAIS and/or its suppliers, and you will not acquire any rights to the Software, except the license expressly set forth above. You will not remove or change any proprietary notices contained in or on the Software. The Software is protected under US patent, copyright, trade secret, and/or other proprietary laws, as well as international treaties. Any transfer, use, or copying of the Software in violation of the License Agreement constitutes copyright infringement. You are hereby on notice that any transfer, use, or copying of the Software in violation of this License Agreement constitutes a willful infringement of copyright.
3. **No Reverse Engineering.** You agree that you will not attempt, and if you employ employees or engage contractors, you will use your best efforts to prevent your employees and contractors from attempting to reverse compile, reverse engineer, modify, translate or disassemble the Software in whole or in part. Any failure to comply with the above or any other terms and conditions contained herein will result in the automatic termination of this license and the reversion of the rights granted hereunder back to TAIS.
4. **Limited Warranty.** THE SOFTWARE IS PROVIDED "AS IS" WITHOUT WARRANTY OF ANY KIND. TO THE MAXIMUM EXTENT PERMITTED BY APPLICABLE LAW, TAIS AND ITS SUPPLIERS DISCLAIM ALL WARRANTIES WITH REGARD TO THE SOFTWARE, EITHER EXPRESS OR IMPLIED, INCLUDING, BUT NOT LIMITED TO, THE WARRANTY OF NON-INFRINGEMENT OF THIRD PARTY RIGHTS. THE WARRANTY OF YEAR 2000 COMPLIANCE, AND THE IMPLIED WARRANTIES OF MERCHANTABILITY AND FITNESS FOR A PARTICULAR PURPOSE. THE ENTIRE RISK AS TO THE QUALITY AND PERFORMANCE OF THE SOFTWARE IS WITH YOU. NEITHER TAIS NOR ITS SUPPLIERS WARRANT THAT THE FUNCTIONS CONTAINED IN THE SOFTWARE WILL MEET YOUR REQUIREMENTS OR THAT THE OPERATION OF THE SOFTWARE WILL BE UNINTERRUPTED OR ERROR-FREE. HOWEVER, TAIS WARRANTS THAT ANY MEDIA ON WHICH THE SOFTWARE IS FURNISHED IS FREE FROM DEFECTS IN MATERIAL AND WORKMANSHIP UNDER NORMAL USE FOR A PERIOD OF NINETY (90) DAYS FROM THE DATE OF DELIVERY TO YOU.
5. **Limitation of Liability.** TAIS' ENTIRE LIABILITY AND YOUR SOLE AND EXCLUSIVE REMEDY UNDER THIS LICENSE AGREEMENT SHALL BE AT TAIS' OPTION REPLACEMENT OF THE MEDIA OR REFUND OF THE PRICE PAID. TO THE MAXIMUM EXTENT PERMITTED BY APPLICABLE LAW, IN NO EVENT SHALL TAIS OR ITS SUPPLIERS BE LIABLE TO YOU FOR ANY CONSEQUENTIAL, SPECIAL, INCIDENTAL OR INDIRECT DAMAGES FOR PERSONAL INJURY, LOSS OF BUSINESS PROFITS, BUSINESS INTERRUPTION, LOSS OF BUSINESS INFORMATION/DATA, OR ANY OTHER PECUNIARY LOSS OF ANY KIND ARISING OUT OF THE USE OR INABILITY TO USE THE SOFTWARE, EVEN IF TAIS OR ITS SUPPLIER HAS BEEN ADVISED OF THE POSSIBILITY OF SUCH DAMAGES. IN NO EVENT SHALL TAIS OR ITS SUPPLIERS BE LIABLE FOR ANY CLAIM BY A THIRD PARTY.
6. **State/Jurisdiction Laws.** SOME STATES/JURISDICTIONS DO NOT ALLOW THE EXCLUSION OF IMPLIED WARRANTIES OR LIMITATIONS ON HOW LONG AN IMPLIED WARRANTY MAY LAST, OR THE EXCLUSION OR LIMITATION OF INCIDENTAL OR CONSEQUENTIAL DAMAGES. SO SUCH LIMITATIONS OR EXCLUSIONS MAY NOT APPLY TO YOU. THIS LIMITED WARRANTY GIVES YOU SPECIFIC RIGHTS AND YOU MAY ALSO HAVE OTHER RIGHTS WHICH VARY FROM STATE/JURISDICTION TO STATE/JURISDICTION.
7. **Export Laws.** This License Agreement involves products and/or technical data that may be controlled under the United States Export Administration Regulations and may be subject to the approval of the United States Department of Commerce prior to export. Any export, directly or indirectly, in contravention of the United States Export Administration Regulations, or any other applicable law, regulation or order, is prohibited.
8. **Governing Law.** This License Agreement will be governed by the laws of the State of California, United States of America, excluding its conflict of law provisions.
9. **United States Government Restricted Rights.** The Software is provided with Restricted Rights. The Software and other materials provided hereunder constitute Commercial Computer Software and Software Documentation and Technical Data related to Commercial Items. Consistent with F.A.R. 12.211 and 12.212 they are licensed to the U.S. Government under, and the U.S. Government's rights therein are restricted pursuant to, the vendor's commercial license.
10. **Severability.** If any provision of this License Agreement shall be held to be invalid, illegal or unenforceable, the validity, legality and enforceability of the remaining provisions hereof shall not in any way be affected or impaired.
11. **No Waiver.** No waiver of any breach of any provision of this License Agreement shall constitute a waiver of any prior, concurrent or subsequent breach of the same or any other provisions hereof, and no waiver shall be effective unless made in writing and signed by an authorized representative of the waiving party.
12. **Supplier Software.** The Software may include certain software provided by TAIS suppliers. In such event, you agree that such supplier may be designated by TAIS as a third party beneficiary of TAIS with rights to enforce the Agreement with respect to supplier's software.

YOU ACKNOWLEDGE THAT YOU HAVE READ THIS LICENSE AGREEMENT AND THAT YOU UNDERSTAND ITS PROVISIONS. YOU AGREE TO BE BOUND BY ITS TERMS AND CONDITIONS. YOU FURTHER AGREE THAT THIS LICENSE AGREEMENT CONTAINS THE COMPLETE AND EXCLUSIVE AGREEMENT BETWEEN YOU AND TAIS AND SUPERSEDES ANY PROPOSAL OR PRIOR AGREEMENT, ORAL OR WRITTEN, OR ANY OTHER COMMUNICATION RELATING TO THE SUBJECT MATTER OF THIS LICENSE AGREEMENT.

Toshiba America Information Systems, Inc.
Telecommunication Systems Division
9740 Irvine Boulevard
Irvine, California 92618-1697
United States of America

5932

DSD 020905

Toshiba America Information Systems, Inc.

Telecommunication Systems Division

End-User Limited Warranty

Toshiba America Information Systems, Inc., ("TAIS") warrants that this telephone equipment manufactured by Toshiba (except for fuses, lamps, and other consumables) will, upon delivery by TAIS or an authorized TAIS dealer to a retail customer in new condition, be free from defects in material and workmanship for twenty-four (24) months after delivery, except as otherwise provided by TAIS in the TAIS warranty accompanying the products or posted on TAIS's website. Products which are not manufactured by Toshiba but are purchased from Toshiba, will be subject to the warranty provisions provided by the equipment manufacturer, unless TAIS notifies the end-user of any additional warranty provisions in writing.

This warranty is void (a) if the equipment is used under other than normal use and maintenance conditions, (b) if the equipment is modified or altered, unless the modification or alteration is expressly authorized by TAIS, (c) if the equipment is subject to abuse, neglect, lightning, electrical fault, or accident, (d) if the equipment is repaired by someone other than TAIS or an authorized TAIS dealer, (e) if the equipment's serial number is defaced or missing, or (f) if the equipment is installed or used in combination or in assembly with products not supplied by TAIS and which are not compatible or are of inferior quality, design, or performance.

The sole obligation of TAIS or Toshiba Corporation under this warranty, or under any other legal obligation with respect to the equipment, is the repair or replacement of such defective or missing parts as are causing the malfunction by TAIS or its authorized dealer with new or refurbished parts (at their option). If TAIS or one of its authorized dealers does not replace or repair such parts, the retail customer's sole remedy will be a refund of the price charged by TAIS to its dealers for such parts as are proven to be defective, and which are returned to TAIS through one of its authorized dealers within the warranty period and no later than thirty (30) days after such malfunction, whichever first occurs.

Under no circumstances will the retail customer or any user or dealer or other person be entitled to any direct, special, indirect, consequential, or exemplary damages, for breach of contract, tort, or otherwise. Under no circumstances will any such person be entitled to any sum greater than the purchase price paid for the item of equipment that is malfunctioning.

To obtain service under this warranty, the retail customer must bring the malfunction of the machine to the attention of one of TAIS' authorized dealers within the applicable warranty period and no later than thirty (30) days after such malfunction, whichever first occurs. Failure to bring the malfunction to the attention of an authorized TAIS dealer within the prescribed time results in the customer being not entitled to warranty service.

THERE ARE NO OTHER WARRANTIES FROM EITHER TOSHIBA AMERICA INFORMATION SYSTEMS, INC., OR TOSHIBA CORPORATION WHICH EXTEND BEYOND THE FACE OF THIS WARRANTY. ALL OTHER WARRANTIES, EXPRESS OR IMPLIED, INCLUDING THE WARRANTIES OF MERCHANTABILITY, FITNESS FOR A PARTICULAR PURPOSE, AND FITNESS FOR USE, ARE EXCLUDED.

No TAIS dealer and no person other than an officer of TAIS may extend or modify this warranty. No such modification or extension is effective unless it is in writing and signed by the Vice President and General Manager, Telecommunication Systems Division.

Contents

Introduction

Organization	5
Conventions	6
Action/Response Table	7
Related Documents/Media	7

Chapter 1 – The Grand Tour

Overview	2
Features to Personalize Your Mailbox	4
Message Queues	4
New Message Queue	4
Saved Message Queue	5
Message Types	6
Forwarded Message	6
Reply Message	6
Greetings	7
Personal	7
System	7
Busy	7
Special Delivery Options	8
Urgent	8
Private	8
Return Receipt	8
Future Delivery	8
Message Destination Selections	9
Personal Distribution Lists	9

System Distribution Lists	10
Directory	10
User Options	10
User Prompts	11
User Tutorial (New User)	11

Chapter 2 – Getting Started

User Tutorial	13
Step 1: Access Your Mailbox	14
From External Telephone	15
From Internal Telephone	15
Step 2: Record Your Name	17
Step 3: Record Your Personal Greeting(s)	18
Step 4: Change Your Security Code	19
Step 5: Exit Your Mailbox or User Mode	20

Chapter 3 – Play Messages

Access Messages	21
Playback Controls	22
Play Your Messages	24
Special Functions	27

Chapter 4 – Send Messages

Recording Controls	31
Send a Message	33
Forward a Message	37
Reply to the Current Message	40
Special Delivery Options	43
Future Delivery	44

Chapter 5 – Manage Mailbox

Change Your Greeting	46
Create or Record Over a Personal Greeting	47
Change Your Greeting Selection	49

Review a Greeting	50
Change Your User Options	51
Change Your Do Not Disturb (DND) Setting	52
Change Your Call Screening Setting	53
Change Your Security Code	54
Create or Record Over Your Busy Greeting	55
Select Your Busy Greeting	56
Record Your Name	57
Change Your Message Notification	58
Review Your Option Settings	60
Manage Your Lists	61
Manage Guest User IDs	63
Use Guest User IDs	64

Chapter 6 – Integration Features

Call Forward	65
Message Waiting	67
Responding to a Lit Msg LED	67
Turning On/Off Message Waiting LED on Another Extension	68
CIX Integration	68
Soft Key Control of Voice Mail	68
Call Record to Voice Mail	73
Direct Transfer to Voice Mailbox	74
Voice Mail Conference	74
Call Monitor	75

Glossary	77
-----------------------	-----------

Introduction

This guide describes the voice messaging capabilities and procedures for making your voice mail system work for you.

Organization

This guide is divided as follows:

- **Chapter 1 – The Grand Tour** is an overview of the voice mail system. Topics covered are: features to personalize your mailbox; an explanation of message queues, types and destinations; special delivery options; playback/recording controls; and available user options.
- **Chapter 2 – Getting Started** provides instructions on those features you need when accessing your voice mail for the first time, including changing your security code and recording your name.
- **Chapter 3 – Play Messages** contains step-by-step instructions on playing messages.
- **Chapter 4 – Send Messages** details how to send, forward, and reply to a message.
- **Chapter 5 – Manage Mailbox** provides step-by-step instructions on recording greetings, using destination (distribution) lists, and activating options such as Do Not Disturb (DND) and Call Screening.
- **Chapter 6 – Integration Features** outlines Call Forward, Message Waiting, Soft Key Control, Call Record, Direct Transfer to Voice Mail, Voice Mail Conferencing and Call Monitor features.
- **Glossary** defines frequently-used voice processing system features and functions.
- **Index**

Conventions

Conventions	Description
Note	Elaborates specific items or references other information. Within some tables, general notes apply to the entire table and numbered notes apply to specific items.
Important!	<i>Calls attention to important instructions or information.</i>
Extension Number	<p>Press to answer a call to the Extension Number. Each station can have multiple extension buttons. Incoming calls ring the extension button(s) from the top down. For example, station 10's extensions ring 10-1 first, then 10-2, 10-3, and 10-4. A station is considered busy when all extensions are being used.</p> <p>Note The naming convention for DKT assignments within Toshiba is Directory Numbers. For clarity and ease of understanding, the terms Extension Number and Phantom Extension Number will be used in this document in lieu of PDN and PhDN.</p>
Arial bold	Represents telephone buttons.
Courier	Shows a computer keyboard entry or screen display.
“Type”	Indicates entry of a string of text.
“Press”	Indicates entry of a single key. For example: Type prog then press Enter .
Plus (+)	Shows a multiple PC keyboard or phone button entry. Entries without spaces between them show a simultaneous entry. Example: Esc+Enter . Entries with spaces between them show a sequential entry. Example: # + 5.
Tilde (~)	Means “through.” Example: 350~640 Hz frequency range.
➤	Denotes the step in a one-step procedure.
➤	Denotes a procedure.

Conventions	Description
See Figure 10	Grey words within the printed text denote cross-references. In the electronic version of this document (Library CD-ROM or FYI Internet download), cross-references appear in blue hypertext.

Action/Response Table

<p><i>Actions</i> you perform appear in this column. They can consist of either a single step or a series of numbered steps.</p>	<p>The <i>immediate response to the action</i> performed appears in this column. Additional notes and comments are also included.</p>
--	---

Related Documents/Media

Note Some documents listed here may appear in different versions on the CD-ROM, FYI, or in print. To find the most current version, check the version/date in the Publication Information on the back of the document's title page.

Important! *Read this User Guide first, then use it with the Quick Reference Guide.*

- Strata CIX General Description
- Strata CIX Installation and Maintenance Manual
- Strata CIX40 Voice Processing GVPH Programming Manual
- Strata CIX40 Voice Processing User Guide
- Strata CIX Library CD-ROM

For authorized users, Internet site FYI (<http://fyi.tsd.toshiba.com>) contains all current documentation and enables you to view, print, and download current publications.

Introduction

Related Documents/Media

This chapter provides an overview of the system and covers the following general topics:

- Features to personalize your mailbox
- Message queues
- Message types
- Greetings
- Special delivery options
- Future delivery
- Message destination selections
- User options
- User prompts
- User tutorial (New User)

Overview

Your voice mail system manages multiple voice processing functions simultaneously 24-hours-a-day, 7-days-a-week. Your mailbox is always available for callers to leave private voice messages. In addition, you can update your greeting at your convenience or send and receive messages from any tone-dialing telephone.

Callers control their own progress through the system. They no longer have to wait for a person to answer the telephone. If your extension is busy or you do not answer, callers can transfer to an operator, call another extension, or record a private, detailed message.

A representative in your company has been assigned as the System Administrator for the system. The System Administrator is responsible for configuring the system and your mailbox to suit your company's needs.

The configuration affects how and which features you can access. Whenever possible, this guide provides information concerning feature exceptions and which features may be configured to work differently.

You can access your mailbox from any tone-dialing telephone using your security code. After you access your voice mail, you hear the number of messages you have in your message queue(s), followed by a prompt from the Main Menu options (see [Figure 1](#)). You can then:

- Listen to your messages
- Send or forward messages
- Reply to messages
- Manage your mailbox (e.g., change your greetings, create distribution lists, etc.)

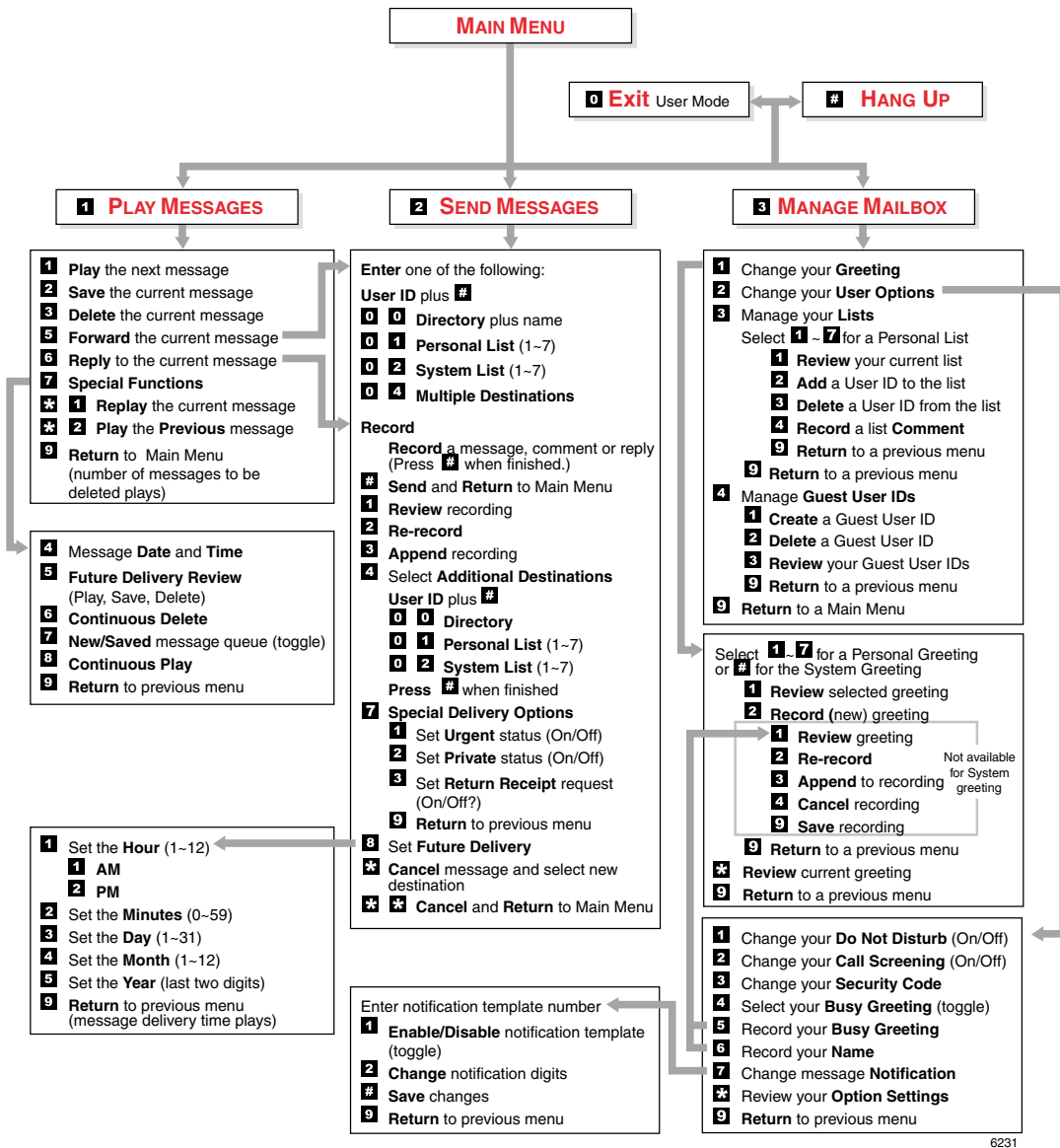

6231

Figure 1 Admin Main Menu

Features to Personalize Your Mailbox

Your voice mail processing system offers a variety of features to personalize your User ID Mailbox. The following are a few of those features:

- **User ID Mailbox Security Code** – Your User ID mailbox has a security code. The code must be entered by you in order to “log into” your User ID mailbox, giving you access to your messages, settings, greetings, etc. (see [“Change Your Security Code” on page 19](#)).
- **Name Recording** – Your name is announced whenever you log onto your mailbox, the directory is accessed, the system greeting is selected, or when a message is sent by another voice mail user. When you first enter your mailbox, you need to record your name (see [“Record Your Name” on page 17](#)).
- **Personal Greetings** – You can record up to seven personal greetings that are played when you are unavailable (see [“Change Your Greeting” on page 46](#)).
- **Guest Users** – You can create Guest User IDs that can be used by clients, friends, etc. Users frequently use this feature to create guest IDs for clients, so that they may easily exchange confidential information (see [“Manage Guest User IDs” on page 63](#)).

Message Queues

Your messages reside in one of two queues—new or saved. Messages play in FIFO (First In, First Out) or LIFO (Last In, First Out) order. Ask your System Administrator to find out how your mailbox is configured.

New Message Queue

Messages in the New Message Queue are New or Pending messages.

New messages consist of messages that are unheard or partially heard (less than five seconds). They remain in the queue, the Message Waiting LED remains on, and a Return Receipt is not sent, if applicable, until the message is completely heard.

Messages that you have partially heard (five seconds or longer) are called Pending messages. They remain in the New Message Queue, the Message Waiting LED is turned off, and a Return Receipt is sent, if applicable.

Note The Pending messages feature is available on a mailbox-to-mailbox basis. Check with your System Administrator to find out if your mailbox is configured for this feature.

When you press **1** from the Main Menu to play messages, your voice mail system automatically accesses the New Message Queue. A new message begins to play based on the type (urgent messages play first) and order received (FIFO/LIFO). If no new messages exist, your voice mail system automatically accesses the Saved Message Queue. If you are in the Saved Message Queue, you can toggle back to the New Message Queue by pressing **77**.

After you play the last message in the queue, your voice mail system prompts, “End of messages.” You can choose to return to the top of the queue, go to the top of the other queue, etc.

Saved Message Queue

Saved messages are messages that you saved or that were automatically saved by your voice mail system at the end of the message.

Access the Saved Message Queue from the Main Menu by pressing **177** or from the New Message Queue by pressing **77**. Your voice mail system automatically accesses the Saved Message Queue when no new messages exist. Saved messages play based on order received (FIFO/LIFO).

After you play the last message in the queue, your voice mail prompts, “End of messages.” You can choose to return to the top of the queue, go to the top of the other queue, etc.

Note Ask your System Administrator to find out if your mailbox is configured with one or two (New and Saved) message queue(s).

Message Types

New and Saved Messages can consist of the following special types of messages—forwarded and message reply.

Forwarded Message

Any message sent to you can be forwarded to a single destination or a personal or system distribution list. When forwarding a message, recording a message (comment) is optional.

Reply Message

Messages to which you want to send an immediate answer can be sent as a reply message. When replying to a message, your voice mail system does not prompt you to select the destination since it “remembers” the source. The Reply feature only works if the original message is sent from another voice mail user on the same system.

When listening to a reply message, a prompt notifies the user of the name/User ID of the person who sent the reply.

Greetings

You can select either a personal or system greeting to play to callers when you do not answer or when your telephone is busy.

Depending on how your system is configured, callers may hear a separate busy greeting—the system or the custom busy greeting. See [“Change Your User Options”](#) on [page 51](#) for details.

Personal

Personal greetings are greetings that you record for callers. Your voice mail system stores all recorded greetings under the personal greeting number (1–7) for your mailbox. Using the greeting number, you can select the greeting which plays.

The System Administrator can also schedule your greetings to automatically play at different times. If you choose, you can override the automatic schedule using the [“Change Your Greeting Selection”](#) on [page 49](#).

System

The system greeting is a standard prerecorded greeting. It cannot be recorded over or deleted. The greeting states, “Please leave a message for (name).” Your voice mail system adds your name from the name recording that you have made (see [“Record Your Name”](#) on [page 17](#)).

Busy

If your User ID mailbox is configured for a personal busy greeting, you can record a custom busy greeting that plays when your extension is busy. If a custom greeting is not recorded, the default system busy greeting plays. See [“Create or Record Over Your Busy Greeting”](#) on [page 55](#) for details.

The custom busy greeting can also be turned on/off using the Select Your Busy Greeting option on the Change Your User Options Menu (see [“Select Your Busy Greeting”](#) on [page 56](#)).

Note The System Administrator must configure your User ID mailbox for the custom busy greeting option to be available.

Special Delivery Options

In addition to recording and sending a new message, you can mark the message urgent, private, or request a return receipt.

Urgent

Messages can be marked urgent by the sender and always play first in the New Message Queue. After the message plays, the urgent status is removed.

Private

Messages can be marked private by the sender. The same options, such as saving and deleting, apply to the private messages; however, a private message cannot be forwarded. Once a message is sent, the private status cannot be removed.

Return Receipt

You can mark a message Return Receipt if you want verification of its receipt. When a user plays (completely or partially) a message marked for Return Receipt, a notification is sent back to the sender. Your voice mail system notifies the sender when and by whom the message was received and plays the original message.

Future Delivery

Your voice mail system can be configured so that your message is delivered at a future time and date specified by you. After marking the message for future delivery, you can review (play, save, delete) the message at any time before it is sent.

Message Destination Selections

At the beginning of the Send Messages menu, you are asked to enter the message destination(s). You can choose to enter a *single* destination (e.g., User ID) or *multiple* destinations (e.g., personal list, User ID, system list). Entering the Multiple Destinations option enables you to address your message to all the recipients at the start of the menu.

You can then record your message and, if desired, add additional destinations when prompted later in the menu. Valid destinations are:

- User ID

Note If you don't know the user's User ID, you can locate the ID on your voice mail system's system-wide directory by pressing **00**.

- Personal distribution list
- System distribution list

See [“Send a Message” on page 33](#) for instructions on using these options.

Personal Distribution Lists

You can originate up to seven Personal Distribution Lists consisting of other system users. You can add or delete users at any time. The lists are for only your use.

At the time you create a list, you are given the option of recording a “list comment” that serves as the title or name for the list. The comment plays each time you use the list to confirm that you have chosen the correct distribution list.

Important! *Try not to duplicate users on your distribution lists. Your voice mail system does not check for duplicates when you send a message using more than one list. For example, if you select Personal Distribution List #1 and #3 as destinations for your message and User ID 1001 is on both lists, User ID 1001 receives the same message twice.*

System Distribution Lists

In addition to Personal Distribution Lists, your voice mail system supports system-wide distribution lists created by the System Administrator for use by everyone in your company. You should check with your System Administrator to find out which lists are available.

Whenever you enter the list number, the “list comment” for the selected system list plays to confirm that you have chosen the right list.

Directory

You can enter the Dual Tone Multi-frequency (DTMF) digits corresponding to the first few letters of a user’s name and your voice mail system plays the recorded name (User ID and optionally the extension) that matches the combination of entered digits. You can then select the name or go on to the next name in the directory.

Each User ID can be identified with up to two names. These names are entered into the automated directory by the System Administrator and enhance the directory’s search/find capabilities. Common choices for the names are the first and last names of the user or the last name of the user and a commonly misspelled version of the last name.

User Options

You can set your telephone for Do Not Disturb (DND) or call screening, select or record a busy greeting (plays when your telephone is busy), and designate where or how you are notified of a message.

The following is a brief description of each of the options. Please see [“Change Your User Options” on page 51](#) for more detailed information.

Important! *The System Administrator must activate these features for them to be available.*

- **DND** – Your voice mail system automatically sends calls to your User ID (mailbox) without first ringing your telephone.
- **Call Screening** – Your voice mail system asks callers for their name and company. Without the caller’s knowledge, the system relays that information to you. You can decide to receive the call, let the call forward to your mailbox, or transfer the call to another extension with or without an announcement.

- **Busy Greeting** – You can record your own custom busy greeting that plays when callers reach your extension, and it is busy.
- **Message Notification** – Your User ID can have up to 10 notification records programmed by the System Administrator with a specific notification method (message waiting lights, stutter dial tone, pagers, voice, etc.) and the time/day when that notification record applies.

Once you have turned on a specific notification record, your voice mail system automatically calls you at the designated number and with the chosen method to notify you of your messages.

User Prompts

Your voice mail system prompts only for menu options available to you. You do not hear prompts for options:

- Not supported by your voice mail system (e.g., future delivery)
- Not configured for your mailbox by the System Administrator (e.g., guest users, do not disturb).

Check with your System Administrator to verify which user options are available to you.

User Tutorial (New User)

A first time user of the voice mail system automatically hears a user-friendly tutorial upon logging in to his/her mailbox. The tutorial walks the user through the process of:

- Recording his/her name (if required)
- Recording a personal greeting for the mailbox
- Changing the default security code

Once the tutorial is completed successfully, it cannot be replayed.

This page is intentionally left blank.

This chapter instructs you on accessing and exiting your mailbox and outlines the user tutorial steps.

User Tutorial

When you log on to the your voice mail system for the very first time, you hear a tutorial that walks you through the following basic steps:

- Record your name (if required). Your name is announced whenever you log onto your mailbox (varies by system), the directory is accessed, the system greeting is selected, or when another voice mail user sends a message to you.
- Record your personal greeting. Your personal greeting automatically plays when you are not available to answer your telephone.
- Change the default security code for your mailbox to ensure privacy. You should change it on a regular basis.

Note If you do not complete the tutorial before hanging up, your voice mail system saves any completed portion (e.g., your name recording) and restarts where you left off the next time you log on to your mailbox. Once the tutorial is completed successfully, it cannot be replayed.

Step 1: Access Your Mailbox

The Main Menu (shown below) is your starting point for all of your voice mail system's messaging features. Pressing **999** from most menus returns you to the Main Menu.

To access your mailbox, you need to know:

- The telephone number to access your voice mail system
- Your User ID number
- Your default security code

Please ask your System Administrator if you do not have this information.



Each time you access your User ID (mailbox), your voice mail system announces:

- Your name (and extension, if applicable)

Note Your voice mail system may not be configured to play your name when you log on to your mailbox.

- The number of new and saved messages you have in your message queue(s)
- The number of messages that will be purged upon exiting your mailbox, if applicable

Your voice mail system then plays the Main Menu options.

If you receive new messages while you are logged on to your mailbox, your voice mail system informs you that you have new messages when you return to the Main Menu.

From External Telephone

- | | |
|--|---|
| 1. From an external telephone, call your voice mail system on _____. | The system answers with your standard company greeting. |
| 2. When voice mail answers, press *. | Your voice mail prompts you to enter your User ID. |
| 3. Enter your User ID + #. | If your voice mail system is designed with a fixed length number for your User ID, do not press # after entering a User ID. See your System Administrator for specific operation of your system.

Your voice mail prompts you to enter your security code. |
| 4. Enter the default security code + #.

If you make a mistake while entering the code, press * to re-enter. | If your voice mail system is designed with a fixed length number for your security code, do not press # after entering the security code. See your System Administrator for specific operation of your system.

You are now in your mailbox. Your voice mail system plays your name and the number of messages you have and then prompts you with a list of choices from the Main Menu. |

From Internal Telephone

- | | |
|--|--|
| 1. From an internal telephone, call your voice mail system on _____. | Your voice mail prompts you to enter your security code. |
|--|--|

Getting Started

Access Your Mailbox

2. Enter the default security code + **#**.

If you make a mistake while entering the code, press ***** to re-enter.

If your voice mail system is designed with a fixed length number for your security code, do not press **#** after entering the security code. See your System Administrator for specific operation of your system.

You are now in your mailbox. Your voice mail system plays your name and the number of messages you have and then prompts you with a list of choices from the Main Menu.

Step 2: Record Your Name

Your name is announced whenever you log onto your mailbox, the directory is accessed, the system greeting is selected, or when a message is sent by another voice mail user.

Note Your voice mail system may not be configured to play your name when you log on to your mailbox.

When you first enter your mailbox, the tutorial prompts you to record your name and walks you through the entire recording sequence. You can re-record your name at any time (see [“Record Your Name” on page 57](#)).

<ol style="list-style-type: none">1. At the tone, state your name slowly and clearly (if you like, you can also state your extension).2. Press # when done.3. After your name plays, press:<ol style="list-style-type: none">1 To accept the recording2 Re-record	<p>Your voice mail plays your name recording.</p> <p>Your recording becomes part of your mailbox and your voice mail system prompts you to record your personal greeting.</p> <p>Your voice mail system returns you to the record your name prompt.</p>
---	---

Step 3: Record Your Personal Greeting(s)

The tutorial now prompts you to record your personal greeting. This greeting becomes your Personal Greeting #1. You can record up to six other greetings (see [“Create or Record Over a Personal Greeting” on page 47](#) for instructions).

Personal greetings should be informative and advise callers when you will be available to return their calls or respond to their messages. You can update personal greetings as often as you want.

Sample Greeting

“Hi. This is Mary Smith of the Toshiba Marketing Department. It is Monday, June 19, and I am in the office today. I am either on the telephone or have stepped away for a few minutes and your call has been forwarded to my voice mailbox. If at the tone you leave a detailed message and a telephone number where I can reach you, I will be happy to return your call.”

1. At the tone, begin recording your greeting.

The following information should be included in your Personal Greeting:

- ◆ Your name
- ◆ Company and/or department
- ◆ Date
- ◆ Your availability
- ◆ Instructions to leave a detailed message
- ◆ Call coverage options

2. Press **#** when done.
3. After your greeting plays, press:

Your voice mail system plays your greeting.

- 1** To accept the recording

Your greeting becomes Personal Greeting #1 and your voice mail system prompts you to change your security code.

- 2** Re-record

Your voice mail system returns you to the record your greeting prompt.

Step 4: Change Your Security Code

The tutorial prompts you to change your mailbox's security code from the preassigned code. You should change your security code on a regular basis thereafter to ensure the privacy of your messages and personal greetings (see [“Change Your Security Code” on page 54](#)).

1. Enter your new security code + #.	The minimum and maximum number of digits for the security code are determined by your System Administrator. Please ask your System Administrator for confirmation on the number.
2. Re-enter your new security code + #.	Your voice mail system prompts you to re-enter your new security code for verification. After entering the security code a second time, your voice mail system announces that your security code has been changed.

You have completed the tutorial. Your voice mail system announces “mailbox number xxx is enabled,” plays your recorded name and announces the number of messages in your mailbox. You can now perform any of the functions available on your voice mail system's Main Menu or exit the mailbox.

Step 5: Exit Your Mailbox or User Mode

- To exit your mailbox, press **#** to hang up from a Toshiba telephone system
...or **999#** to hang up from another manufacturer's telephone system
...or to exit the user mode, press **0**.

When you press **#** to hang up, you hear "Thank you for calling. Good-bye."

Your voice mail system can be configured so that you can exit your mailbox without leaving the voice mail system. Please ask your System Administrator to find out if your system is configured for this or some other function when pressing **0**.

If you have the "0 to EXIT User Mode" capability, you hear the voice mail system's company greeting. You can now access another user or a different mailbox.

This chapter explains how to use the Play Messages feature. It discusses:

- Access Messages
- Playback Controls
- Play your messages
- Special functions

Depending upon your telephone system and telephone, a message waiting light is lit on your telephone when a voice message has been left for you on the voice mail system.

If configured, your voice mail system automatically turns off your message waiting light on your telephone when your new message queue is empty or only Pending messages remain (see [“Message Queues” on page 4](#)). The Message Waiting LED remains on only if there are *new* messages in the queue.

Access Messages

Once you press **1** to play your messages, the following telephone keys assist you in going through your messages:

- 1** Takes you to the next message or back to the top of the queue when you have reached the last message in the queue.
- *1** Replays the current message.
- *2** Takes you to the previous message or back to the last message in the queue when you have reached the top of the message queue.
- 77** Toggles between the New and Saved Message Queues.

If new messages arrive while you are accessing your mailbox, your voice mail system notifies you that a new message is in the queue upon returning to the Main menu.

Playback Controls

While playing a message, you can pause, control the volume, location, and speed of playback using the following keys (shown below).

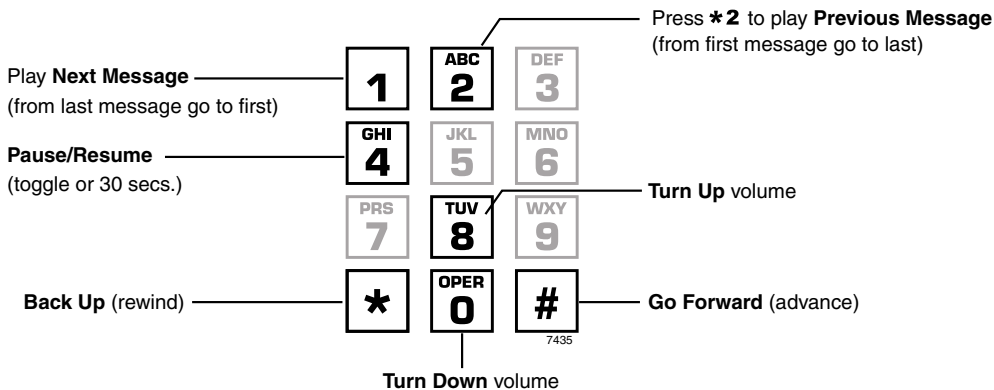

1 Play Next Message

Plays next message in queue. If you are at the last message in the queue, goes to the first message in the same queue.

***2 Play Previous Message**

Plays previous message in queue. If you are at the first message in the queue, goes to the last message in the same queue.

4 Pause/Resume (toggle or 30 seconds)

At any time while playing messages, you can press **4** to pause the playback for 30 seconds. The message resumes playing as soon as you press **4** or automatically at the end of 30 seconds. You can pause the playback as many times as necessary.

8 Turn Up Volume, 0 Turn Down Volume

Each time you press **8** or **0**, the volume of messages adjusts one increment until the maximum number of increments is reached. Your voice mail system saves the current level when you exit.

*** Back Up (rewind)**

The message backs up/rewinds and then begins playing. The default is five seconds (set by the System Administrator).

Go Forward (advance)

The message goes forward/advances and then begins playing. The default is five seconds (set by the System Administrator).

Play Your Messages

When you access your mailbox, your voice mail system tells you the number of urgent, new and saved messages (if supported by your system; check with your System Administrator) you have in your mailbox. If your mailbox is empty, the voice mail system prompts do not include “press **1** to play messages.”

When you press **1** from the Main Menu to play messages (menu shown below), your voice mail system automatically accesses the New Message Queue. If no messages exist in the New Message Queue, your voice mail system automatically accesses the Saved Message Queue.

From the Main Menu:

1 Play Messages

- 1 Play** the next message
- 2 Save** the current message
- 3 Delete** the current message
- 5 Forward** the current message
- 6 Reply** to the current message
- 7 Special Functions**
 - 4 Message Date and Time**
 - 5 Future Delivery Review** (Play, Save, Delete)
 - 6 Continuous Delete**
 - 7 New/Saved** message queue (toggle)
 - 8 Continuous Play**
 - 9 Return** to previous menu
- * 1 Replay** the current message
- * 2 Play** the **Previous** message
- 9 Return** to the Main Menu

While playing a message, you can press:

- 4 Pause/Resume** (toggle or 30 seconds)
- 8 Turn Up** volume
- 0 Turn Down** volume
- * Backup** (rewind)
- # Go Forward** (advance)

7399

1. From the Main Menu, press **1** Play Messages.

While the message plays, you can select **4** pause/resume, **8** turn up volume, **0** turn down volume, ***** back up (rewind), **#** go forward (advance)

2. (Optional) While the message plays or immediately after, you can select *one* of the following:

1 *Play the next message*

2 *Save the current message*

3 *Delete the current message*

A message plays.

Once you play a message, your voice mail system prompts you with the Play Messages Menu until you press **9** to exit the menu or you activate another selection.

Skips to the beginning of the next message.

Note If you reach the end of your messages, pressing **1** takes you back to the top of the same queue.

Saves the current message. The Play Messages Menu plays.

Flags the current message for deletion. The Play Messages Menu plays. When you exit Play Messages, your voice mail system tells you the number of messages to be deleted. If you do not want to delete a message, save the message before exiting your mailbox.

Note Your voice mail system can be programmed to delete messages after a preset length of time. Consult your System Administrator. Your voice mail system notifies you before purging messages.

Play Messages

Play Your Messages

5 <i>Forward the current message</i>	With the exception of private messages, all messages can be forwarded to a single user, multiple users, or a destination list. See “Forward a Message” on page 37 for details on this feature.
6 Reply to the current message	Your reply is sent to the originator of the message. In addition, you can send your reply to a single user, multiple users, or a destination list. See “Reply to the Current Message” on page 40 for details on this feature.
7 <i>Special Functions</i>	Your voice mail system prompts with the options. See “Special Functions” on page 27 for instructions on using this option.
*1 Replay the current message	The current message plays from the beginning.
*2 Play the previous message	The previous message plays from the beginning. Note If you are at the top of the message queue, pressing *2 takes you to the bottom of the same queue.
9 <i>Return to Main Menu</i>	Your voice mail system tells you the total number of messages that will be deleted when you log out of your mailbox, and then returns to the Main Menu.

Special Functions

You can check the date and time a message was sent, or review a message set for future delivery in the Play Messages menu.

When you play a message, this option is available by pressing **7** *Special Functions*.

➤ Press an option number:

4 *Message Date and Time*

The date and time the message was received plays, followed by the entire message.

Note If your System Administrator programmed an automatic date and time stamp for all messages, the stamp plays automatically at the beginning of each message.

5 Future Delivery Review

Your voice mail system plays your name, the future delivery time/date the message will be sent and the entire message. Your voice mail system automatically saves the message for future delivery.

While the message is playing or immediately after, you can select any of the following:

1 *Play the next message*

Skips to the beginning of the next future delivery message.

2 *Save the current message*

Saves the current future delivery message.

3 *Delete the current message*

Flags the current future delivery message for deletion. When you exit the future delivery review, voice mail tells you the number of messages to be deleted. If you do not want to delete a message, save the message before exiting the future delivery review.

Play Messages

Special Functions

<p>9 <i>Return to the Special Functions Menu</i></p>	<p>Your voice mail system tells you the total number of messages that will be deleted when you log out of your mailbox, and then returns to the Special Functions Menu.</p>
<p>6 Continuous Delete</p>	<p>Deletes multiple messages at one time in your New or Saved Message Queue without additional action from you.</p> <p>Note See the Continuous Play feature on page 28 before using Continuous Delete.</p> <p>The number of messages deleted is based on a preset length of time (designated in minutes) set on a system-wide basis by your System Administrator.</p> <p>Important! <i>The deletion starts with the first message in the queue and continues until the preset time has expired. Both heard and unheard messages are deleted. If there are two queues—new and saved—the deletion occurs only in the queue you are in when you press 6 for continuous delete.</i></p>
<p>7 New/Saved message queue (toggle)</p>	<p>Ask your System Administrator to verify that you have this option.</p> <p>This feature operates as a toggle; use it to move back and forth between the New and Saved Message Queues.</p>
<p>8 <i>Continuous Play</i></p>	<p>Plays multiple messages at one time in your New or Saved Message Queue without additional action from you.</p> <p>The number of messages played is based on a preset length of recorded time (designated in minutes) and therefore varies. (Your System Administrator sets the length of time on a system-wide basis.) The messages played are those whose cumulative time is equal to, or less than, the designated number of minutes.</p>

9 *Return to previous menu*

Important! *The playback starts with the first message in the queue and continues until the preset time has expired. If there are two queues—new and saved—the playback occurs only in the queue you are in when you press **8** for continuous playback.*

Ask your System Administrator to verify that you have this option.

Your voice mail system returns to the Play Messages Menu.

This page is intentionally left blank.

From any tone-dialing telephone, you can record and send a message to a user, several users, or to a personal or system distribution list.

This chapter covers:

- Recording controls
- Send a message
- Forward a message
- Reply to the current message
- Special delivery options
- Future delivery

Recording Controls

While recording a message, you can pause/resume the recording or end the recording using the following keys (shown below).

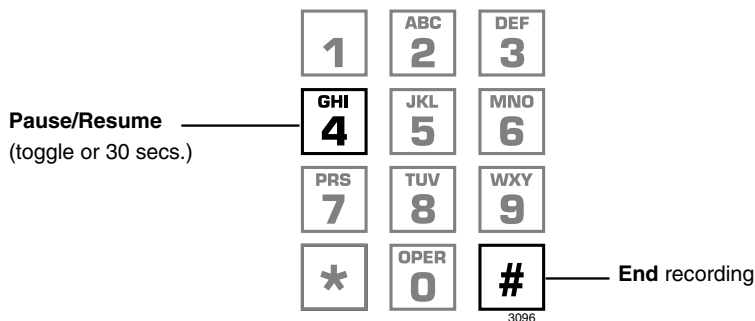

4 Pause/Resume (toggle or 30 seconds)

At any time while recording messages to another mailbox in the system, you can press **4** to pause for 30 seconds. The message resumes recording as soon as you press **4**. Your voice mail system prompts you with, "Begin recording... (Beep)."

If within the 30 seconds you do not press **4**, voice mail restarts another 30-second pause. If during the second 30-second pause you:

- Do not press any key, voice mail assumes you have cancelled the message and returns to the Main Menu.
- Press **#**, your voice mail system returns you to the Send Messages Menu and you can send, review or record over the message.

End Recording

After recording a message, press **#** to end the recording.

Send a Message

Using the Send Messages Menu (shown below), you can record a message and send it to a single mailbox or multiple destinations (e.g., personal or system distribution list), forward a message (with a comment), or reply to a message sent you.

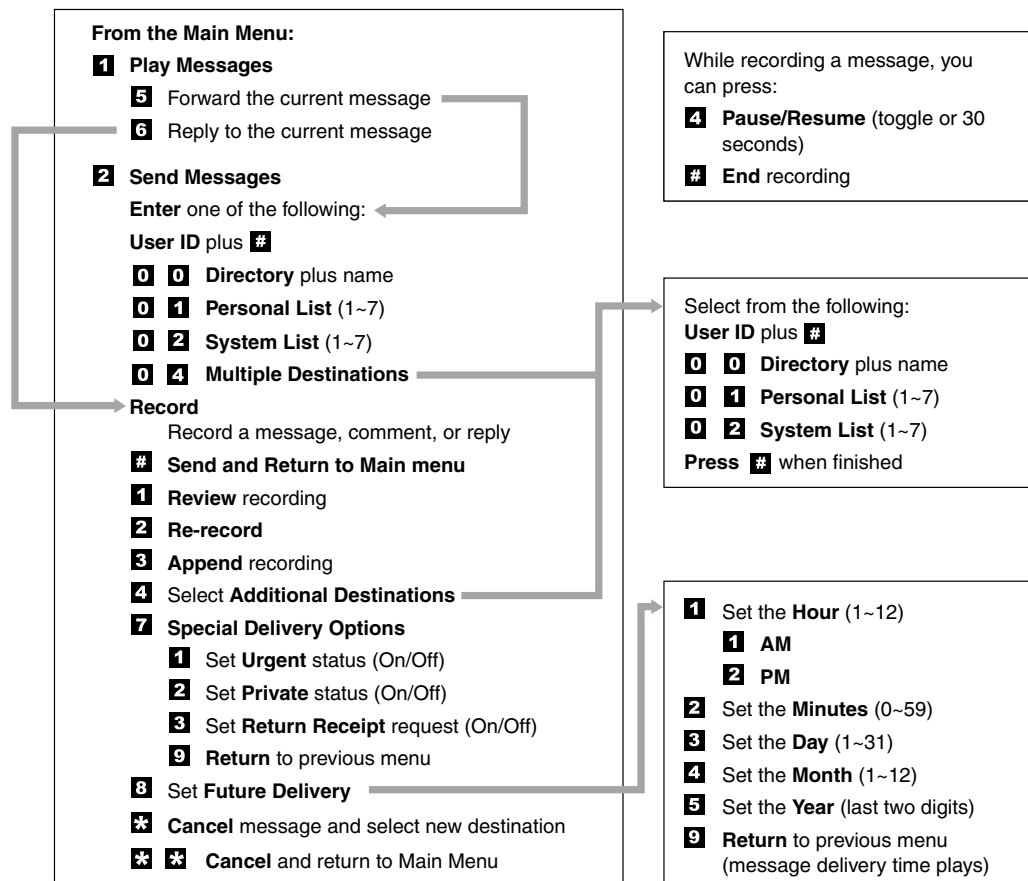

Send Messages

Send a Message

-
- | | |
|---|---|
| <ol style="list-style-type: none">1. From the Main Menu, press 2 Send Messages.
2. Enter one of the following destinations:<ul style="list-style-type: none">♦ User ID and press #. Press # again to record a message without playing the user's name.
♦ 00Directory
Enter the first few letters of the first or last name (Q=7, Z=9).

Press # to select the name as the destination

...or 1 to hear the next name

...or * to cancel your entry and re-enter. | <p>Your voice mail system prompts you to enter the destination (i.e., User ID, Personal, System List, or Multiple Destinations).</p> <p>Note A message can be sent to a total of 33 destinations, including destinations entered in the 4 Additional Destinations option (see “4 Select Additional Destinations” on page 36). A list counts as one destination.</p> <p>Your voice mail system plays the user's name or User ID for confirmation.</p> <p>Note If your voice mail system is designed with a fixed length number for your User ID, do not press # after entering a User ID. See your System Administrator for specific operation of your system.</p> <p>You are prompted to enter the person's name.</p> <p>Your voice mail system plays the first name that matches the combination of letters you entered.</p> |
|---|---|

- | | |
|---|---|
| <ul style="list-style-type: none"> ◆ 01 Personal List <p>Enter a list number
(1~7).</p> | <p>You are prompted for the destination list number.</p> <p>Your voice mail system plays the list comment or number for confirmation. See “Manage Your Lists” on page 61 to create or revise a destination (distribution) list.</p> |
| <ul style="list-style-type: none"> ◆ 02 System List <p>Enter a list number
(1~7).</p> | <p>You are prompted for the destination list number.</p> <p>Your voice mail system plays the list comment or number for confirmation. Ask your System Administrator for more information about System Lists.</p> |
| <ul style="list-style-type: none"> ◆ 04 Multiple Destinations | <p>You are prompted for the destinations: User ID, 00, 01 Personal List and/or 02 System List.</p> |
| <p>3. Record a message after the tone. When finished, press #.</p> <p>While recording, you can press 4 to pause/resume (toggle or 30 seconds) the recording.</p> | |
| <p>4. Press # again to send the message immediately</p> | <p>Your voice mail system tells you that your message has been sent and returns you to the Main Menu.</p> |
| <p>...or before sending the message, you can use any of the following options:</p> <ul style="list-style-type: none"> 1 <i>Review recording</i> 2 <i>Re-record</i> <p>Press # when done.</p> | <p>Important! <i>If you press # to send your message, you cannot use the special recording and sending options.</i></p> <p>The recording plays.</p> <p>The system prompts you to record at the beep.</p> |

Send Messages

Send a Message

3 <i>Append recording</i> Press # when done.	The appended recording plays after the already recorded portion of the message. The system prompts you to record at the beep.
4 <i>Select Additional Destinations</i>	Send the message to additional destinations. Valid entries: User ID, 00, 01 and 02 . You cannot enter 04 Multiple Destinations.
7 <i>Special Delivery Options</i>	You can send a message as urgent, private, or with a return receipt request. The settings can be used in any combination and changed prior to sending the message. See “ Special Delivery Options ” on page 43 for instructions on using this option.
8 <i>Set Future Delivery</i>	You can have your message delivered at a future specified time and date. See “ Future Delivery ” on page 44 for instructions on using this option.
* Cancel message and select new destination	Cancels the message and returns you to Step 2 on page 34 .
** Cancel and Return to the Main Menu	Cancels the message and returns you to the Main Menu.

Forward a Message

Any message sent to you can be forwarded to a single destination or a personal or system distribution list. When forwarding a message, recording a message (comment) is optional.

1. From the Play Messages Menu, press **5** Forward the current message.

Your voice mail system prompts you to enter the destination (i.e., User ID, Personal, System List or Multiple Destinations).

2. Enter one of the following destinations:

Note A forwarded message can be sent to a total of 33 destinations, including destinations entered in the **4** Additional Destinations option (see [“4 Select Additional Destinations” on page 39](#)). A list counts as one destination.

- ◆ User ID and press **#**. Press **#** again to record a message without playing the user's name.

Your voice mail system plays the user's name or User ID for confirmation.

Note If your voice mail system is designed with a fixed length number for your User ID, do not press **#** after entering a User ID. See your System Administrator for specific operation of your system.

- ◆ **00**Directory

Enter the first few letters of the first or last name (Q = 7, Z = 9).

Press **#** to select the name as the destination

...or **1** to hear the next name

...or ***** to cancel your entry and re-enter.

You are prompted to enter the person's name.

Your voice mail system plays the first name that matches the combination of the letters you entered.

Send Messages

Forward a Message

<ul style="list-style-type: none">◆ 01 Personal List <p>Enter a list number (1~7).</p>	<p>You are prompted for the destination list number.</p> <p>Your voice mail system plays the list comment or number for confirmation. See “Manage Your Lists” on page 61 to create or revise a destination (distribution) list.</p>
<ul style="list-style-type: none">◆ 02 System List <p>Enter a list number (1~7).</p>	<p>You are prompted for the destination list number.</p> <p>Your voice mail system plays the list comment or number for confirmation. Ask your System Administrator for more information about System Lists.</p>
<ul style="list-style-type: none">◆ 04 Multiple Destinations	<p>You are prompted for the destinations: User ID, 00, 01 Personal List and/or 02 System List.</p>
<p>3. (Optional) Record a message (comment) after the tone. When finished, press #.</p> <p>While recording, you can press 4 to pause/resume (toggle or 30 seconds) the recording.</p>	
<p>4. Press # again to forward the message immediately</p>	<p>Your voice mail system tells you that your message has been forwarded and returns you to the Main Menu.</p>
	<p>Important! <i>If you press # to forward your message, you cannot use the special recording and sending options.</i></p>
<p>...or before sending the message, you can use any of the following options:</p> <ul style="list-style-type: none">1 Review recording	<p>The forwarding comment plays.</p>

2 Re-record Press # when done.	The system prompts you to record the comment at the beep.
3 Append recording Press # when done.	The appended forwarding comment plays after the already recorded message comment. The system prompts you to record at the beep.
4 Select Additional Destinations	Send the forwarded message to additional destinations. Valid entries: User ID, 00, 01 and 02 . You cannot enter 04 Multiple Destinations.
7 <i>Special Delivery Options</i>	You can send a message as urgent, private, or with a return receipt request. The settings can be used in any combination and changed prior to sending the message. See “ Special Delivery Options ” on page 43 for instructions on using this option.
8 <i>Set Future Delivery</i>	You can have your message delivered at a future specified time and date. See “ Future Delivery ” on page 44 for instructions on using this option.
* Cancel message and select new destination	Cancels the message and returns you to Step 2 on page 37 .
** Cancel and Return to the Main Menu	Cancels the message and returns you to the Main Menu.

Send Messages

Reply to the Current Message

Reply to the Current Message

Your voice mail system lets you reply to a message that you are currently playing. When you reply to a message, you do not have to select the source of the message as a destination since your voice mail system “remembers” it. You can send the reply to additional destinations.

When the originator(s) receives and plays the reply, he/she hears the prompt, “Reply message from [name or User ID].”

Important! *The Reply feature only works if the original message is sent from a another voice mail user. When a voice mail user that has not logged on to his/her mailbox leaves a message for you, you have to enter a destination to respond.*

1. From the Play Messages Menu, press **6** Reply to the current message.

2. Record your reply after the tone. When finished, press **#**.

While recording, you can press **4** to pause/resume (toggle or 30 seconds) the recording.

3. Press **#** again to send the reply immediately

...or before sending the reply, you can use any of the following options:

- 1** Review reply

You are prompted to record your reply to the message.

Your voice mail system tells you that your reply has been sent and returns you to the Main Menu.

Important! *If you press **#** to send your reply you cannot use the special recording and sending options.*

The recording plays.

<p>2 Re-record Press # when done.</p> <p>3 Append reply Press # when done.</p> <p>4 <i>Select Additional Destinations</i> Enter one of the following destinations:</p> <ul style="list-style-type: none"> • User ID and press #. Press # again to record a reply without playing the user's name. • 00 Directory Enter the first few letters of the first or last name (Q = 7, Z = 9). Press # to select the name as the destination ...or 1 to hear the next name ...or * to cancel your entry and re-enter. 	<p>The system prompts you to record your reply at the beep.</p> <p>The appended reply plays after the already recorded portion. The system prompts you to record at the beep.</p> <p>Send the message to additional destinations. You may repeat this step as often as necessary.</p> <p>Your voice mail system plays the user's name or User ID for confirmation.</p> <p>Note If your voice mail system is designed with a fixed length number for your User ID, do not press # after entering a User ID. See your System Administrator for specific operation of your system.</p> <p>You are prompted to enter the person's name.</p> <p>Your voice mail system plays the first name that matches the combination of the letters you entered.</p>
--	--

Send Messages

Reply to the Current Message

<ul style="list-style-type: none">• 01 Personal List Enter a list number (1~7).	<p>You are prompted for the destination list number.</p> <p>Your voice mail system plays the list comment or number for confirmation. See “Manage Your Lists” on page 61 to create or revise a destination (distribution) list.</p>
<ul style="list-style-type: none">• 02 System List Enter a list number (1~7).	<p>You are prompted for the destination list number.</p> <p>Your voice mail system plays the list comment or number for confirmation. Ask your System Administrator for more information about System Lists.</p>
7 <i>Special Delivery Options</i>	<p>You can send a message as urgent, private, or with a return receipt request. The settings can be used in any combination and changed prior to sending the message.</p> <p>See “Special Delivery Options” on page 43 for instructions on using this option.</p>
8 <i>Set Future Delivery</i>	<p>You can have your message delivered at a future specified time and date. See “Future Delivery” on page 44 for instructions on using this option.</p>
* <i>Cancel reply</i>	<p>Cancels the reply and returns you to Step 2 on page 40.</p>
** <i>Cancel and Return to the Main Menu</i>	<p>Cancels the message and returns you to the Main Menu.</p>

Special Delivery Options

You can send a message as urgent, private, or with a return receipt request. The settings can be used in any combination and changed prior to sending the message.

When you send, forward or reply to a message, this option is available by pressing **7** Special Delivery Options.

➤ Enter an option number:

- 1** Set Urgent status (toggle)

To remove the urgent status, press **7** then **1** again.

- 2** Set Private status (toggle)

To remove the private status, press **7** then **2** again.

- 3** Set Return Receipt request (toggle)

To remove the return receipt request, press **7** then **3** again.

- 9** Return to previous menu

Urgent messages play first in the New Message Queue.

Private messages cannot be forwarded.

Your voice mail system notifies you when and by whom the message was received and plays the original message.

Note A message that is only partially heard (for five seconds or longer) sends back a return receipt to the sender.

Your voice mail system returns you to the previous menu.

Future Delivery

Your voice mail system can be configured so that your message is delivered at a future specified time and date. After marking the message for future delivery, you can review (play, save, delete) the message at any time before it is sent. See [Chapter 3 – Play Messages](#) for instructions on using the Future Delivery Review option.

When you send, forward or reply to a message, this option is available by pressing **8** Set Future Delivery. You can choose any or all of the selections.

► Enter an option number and press **#**.

- 1** Set Hour (**1~12**)
 - 1** AM
 - 2** PM
- 2** Set Minutes (**0~59**)
- 3** Set Day (**1~31**)
- 4** Set Month (**1~12**)
- 5** Set the Year (last two digits)
- 9** *Return to previous menu*

Each of these settings default to the current time/date. To set a future delivery time, you do not need to enter all the options. For example, if you have recorded a message and want to have it delivered that afternoon at 2:30 PM, you only need to enter the hour (2), select PM and enter the minutes (30) using options 1 and 2.

Your voice mail system prompts you to select AM or PM.

Two-digit numbers under 80 will be set for the next century. For example, enter **59** to set 2059.

Your voice mail system plays the message delivery time and date and returns you to the previous menu.

Note You can review, continue to send (save), or delete this message using the Future Delivery Review option on the Play Messages Menu. (See [Chapter 3 – Play Messages](#)).

Your voice mail system provides special options to customize and manage your mailbox features (menu shown below).

From the Main Menu:

- 3** **Manage Mailbox**
- 1** Change your **Greeting**
- 2** Change your **User Options**
- 3** Manage your **Lists**
- 4** Manage your **Guest User IDs**
- 9** **Return** to Main Menu

Change Your Greeting

You can select either a personal or system greeting to play callers when you do not answer or when your telephone is busy.

This section discusses the three basic greeting controls (menu shown below):

- Create or record over a personal greeting
- Change your greeting selection
- Review a greeting

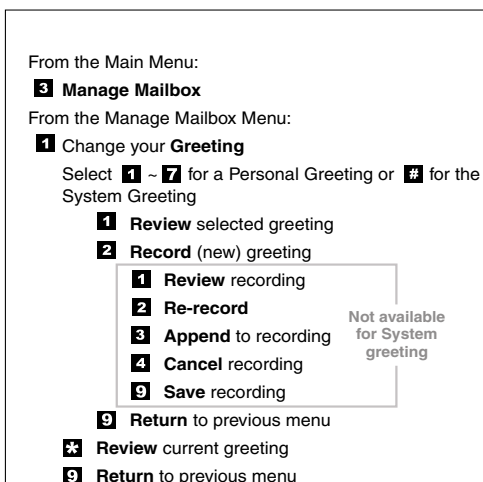

3608

Create or Record Over a Personal Greeting

Personal greetings should be informative and advise callers when you will be available to return their calls or respond to their messages. You can update personal greetings as often as you want. You can store up to seven different recorded greetings from which you can choose as your personal greeting. The System Administrator can also schedule your greetings to play automatically at different times.

1. From the Manage Mailbox Menu, press **1** Change your Greeting.

2. Enter a number from **1~7**.

3. Press **2** to record the greeting (speak slowly and clearly).

4. Press **#** when done.

Your voice mail system prompts with a list of options from the Change your Greeting Menu.

Your greeting is identified by the number chosen. For example, you can record a general greeting as greeting 1, then record a greeting for holidays as greeting 2. Later, you can choose which one plays. You can re-record a greeting at any time.

The following information should be included in your Personal Greeting:

- ◆ Your name
- ◆ Company and/or department
- ◆ Date
- ◆ Your availability
- ◆ Instructions to leave a detailed message
- ◆ Call coverage options

Sample Greeting

“Hi. This is Mary Smith of the Toshiba Marketing Department. It is Monday, June 19, and I am in the office today. I am either on the telephone or have stepped away for a few minutes and your call has been forwarded to my voice mailbox. If at the tone you leave a detailed message and a telephone number where I can reach you, I will be happy to return your call.”

Manage Mailbox

Change Your Greeting

-
- | | |
|---|--|
| <p>5. (Optional) After recording, you can press:</p> <ul style="list-style-type: none">1 Review recording2 Re-record
Press # when done.3 Append recording
Press # when done.4 Cancel recording9 Save recording | <p>The complete greeting plays.</p> <p>The system prompts you to record at the beep.</p> <p>Appending a greeting enables you to add information to the end of your already recorded greeting. The system prompts you to record at the beep.</p> <p>The greeting is canceled. The system returns to the previous menu.</p> <p>Your voice mail system tells you that greeting (number) has been recorded and returns to the previous menu. Again, you are given the option to review or record over the greeting you have just recorded.</p> |
| <p>6. Press 9 to return to the previous menu.</p> | <p>You are given the option to record another greeting.</p> |
| <p>7. Press 1 and select another greeting number (1~7).</p> | |
| <p>8. Repeat Step 3 on page 47.</p> | |
| <p>9. To return to the Main Menu, press 999.</p> | <p>Important! <i>The last greeting selected or recorded is the greeting that callers hear as your User ID greeting.</i></p> <p>Your voice mail system plays the Main Menu options.</p> |

Change Your Greeting Selection

- | | |
|--|---|
| <ol style="list-style-type: none">1. From the Main Menu, press 3 <i>Manage Mailbox</i>.2. Press 1 <i>Change your Greeting</i>.3. Enter a personal greeting number (1~7)

...or # to select the system greeting.

...or * to review the current greeting.4. Press 9 to return to the previous menu

...or 99 to return to the Manage Mailbox Menu

...or 999 to return to the Main Menu. | <p>Your voice mail system plays the Manage Mailbox Menu.</p> <p>Your voice mail system prompts with a list of options from the Change Your Greeting Menu.</p> <p>Your callers hear the selected greeting when you do not answer or when your telephone is busy.</p> <p>Your callers hear the system greeting when you do not answer or when your telephone is busy.</p> <p>Note If you have recorded a busy greeting, this greeting does not play when your telephone is busy (see “Create or Record Over Your Busy Greeting” on page 55 for details).</p> <p>Important! <i>The last greeting selected or recorded is the greeting that callers hear as your User ID greeting.</i></p> <p>The current greeting plays.</p> <p>Your voice mail system returns to the previous menu.</p> <p>You can select another user Manage Mailbox option.</p> <p>You can select another Main Menu option.</p> |
|--|---|

Review a Greeting

1. From the Main Menu, press **3** *Manage Mailbox*.
2. Press **1** *Change your Greeting*.
3. Press ***** to review the current greeting

...or enter a number from **1~7**, then press **1** to review the greeting. Press **9** to return to previous menu.

4. Press **9** to return to the Manage Mailbox Menu

...or **99** to return to the Main Menu.

Your voice mail system plays the Manage Mailbox Menu.

Your voice mail system plays a list of options from the Change Your Greeting Menu.

The current greeting plays. Your voice mail system prompts you with the Change Your Greeting Menu options.

Note Pressing ***** does not affect the current greeting selection.

The greeting plays. Your voice mail system prompts you with the Change Your Greeting Menu options.

You can select another user Manage Mailbox option.

You can select another Main Menu option.

Change Your User Options

Your voice mail system provides a number of special options to improve time management and productivity (menu shown below). For example, the DND feature can provide blocks of time for meetings or projects uninterrupted by the ringing of a telephone.

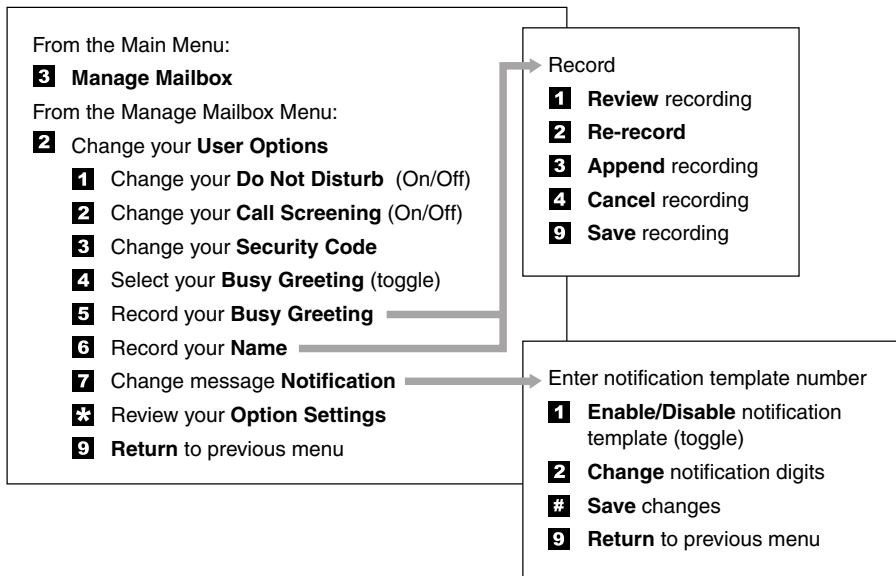

3612

Important! *If you do not hear all the options for this menu, they may not be configured for your telephone or system. Please ask your System Administrator to verify which user options are available to you.*

Change Your Do Not Disturb (DND) Setting

If you set this feature to on, your voice mail system automatically sends calls to your User ID (mailbox) without first ringing your telephone. The System Administrator can also set this feature to turn on or off automatically at pre-scheduled times and/or days of the week.

1. From the Main Menu, press **3** *Manage Mailbox*.
2. Press **2** *Change your User Options*.
3. Press **1** *Change your Do Not Disturb (On/Off)*.

4. (Optional) Press **1** again to reset the feature, if required.
5. Press **9** to return to the Manage Mailbox Menu

...or **99** to return to the Main Menu.

Your voice mail system plays the Manage Mailbox Menu.

A prompt verifies the current status of the feature.

Important! *DND on the your voice processing system is different from the DND features for your telephone system. If your telephone comes with a DND button or feature, it works independently from this feature on your voice mail system.*

Pressing **1** toggles the DND feature On and Off.

You can select another user Manage Mailbox option.

You can select another Main Menu option.

Change Your Call Screening Setting

If you set this feature to on, your voice mail system asks callers for their name and company. Without the caller's knowledge, the system relays that information to you and provides you with special options to handle the call (menu shown below).

- | |
|--|
| <ul style="list-style-type: none">1 Receive the call2 Reject the call and let the call forward to your mailbox3 Transfer the call to another extension with an announcement4 Transfer the call to another extension without an announcement |
|--|

The System Administrator can also set this feature to turn on or off automatically at pre-scheduled times and/or days of the week.

- | | |
|---|---|
| <ol style="list-style-type: none">1. From the Main Menu, press 3 <i>Manage Mailbox</i>.2. Press 2 <i>Change your User Options</i>.3. Press 2 <i>Change your Call Screening (On/Off)</i>.4. (Optional) Press 2 again to reset the feature, if required.5. Press 9 to return to the Manage Mailbox Menu

...or 99 to return to the Main Menu. | <p>Your voice mail system plays the Manage Mailbox options.</p> <p>A prompt verifies the current status of the feature.</p> <p>Pressing 2 toggles the Call Screening feature On and Off.</p> <p>You can select another user Manage Mailbox option.</p> <p>You can select another Main Menu option.</p> |
|---|---|

Change Your Security Code

Each User ID in the system has a security code. The code must be entered by you in order to “log on” to your User ID mailbox, enabling you to access your messages, settings, greetings, etc.

Note You can change your security code as often as you wish to ensure the privacy of your messages and personal greetings.

-
- | | |
|---|---|
| 1. From the Main Menu, press 3 Manage Mailbox. | Your voice mail system prompts with a list of options from the Manage Mailbox Menu. |
| 2. Press 2 Change your User Options. | Your voice mail system prompts with a list of options from the Change your User Options Menu. |
| 3. Press 3 Change your Security Code. | Your voice mail system prompts you to enter your new security code. |
| 4. Enter your new security code + # . | The minimum and maximum number of digits for the security code are determined by your System Administrator. Please ask your System Administrator for confirmation on the number.

Your voice mail system prompts you to re-enter your new security code for verification. |
| 5. Re-enter your new security code + # . | After entering the security code a second time, your voice mail system announces that your security code has been changed. |

Create or Record Over Your Busy Greeting

You can record your own custom busy greeting that plays when callers reach your extension and it is busy. While your callers are listening to the busy greeting, they can enter a different User ID, press * to hold (if configured for your mailbox by the System Administrator), or remain on the line to leave a message.

Note Depending on the configuration of your telephone and telephone system, Stratagy may not receive a busy tone when callers reach your extension. If Stratagy doesn't receive a busy tone, your selected personal greeting plays instead.

If a custom greeting is not recorded, the default system busy greeting plays.

1. From the Main Menu, press 3 <i>Manage Mailbox</i> .	Your voice mail system plays the Manage Mailbox options.
2. Press 2 <i>Change your User Options</i> .	
3. Press 5 <i>Record your Busy Greeting</i> .	Your voice mail system prompts you to record your custom busy greeting.
4. Begin recording at the tone. Press # when done.	
5. (Optional) After recording, you can press:	
1 <i>Review greeting</i>	The complete greeting plays.
2 <i>Re-record</i> Press # when done.	The system prompts you to record at the beep.
3 <i>Append recording</i> Press # when done.	The system prompts you to record at the beep. The appended greeting plays after the already recorded portion of the greeting.
4 <i>Cancel recording</i>	The greeting is canceled. The system returns to the previous menu.
9 <i>Save recording</i>	Your voice mail system tells you that the greeting has been saved and returns to the previous menu.

Manage Mailbox

Change Your User Options

6. Press **9** to return to the Manage Mailbox Menu

...or **99** to return to the Main Menu.

You can select another user Manage Mailbox option.

You can select another Main Menu option.

Select Your Busy Greeting

1. From the Main Menu, press **3** *Manage Mailbox*.

2. Press **2** *Change your User Options*.

3. Press **4** *Select your Busy Greeting (toggle)*.

4. (Optional) Press **4** again to reset the feature, if required.

5. Press **9** to return to the Manage Mailbox Menu

...or **99** to return to the Main Menu.

Your voice mail system plays the Manage Mailbox options.

A prompt verifies the current status of the feature.

Pressing **4** toggles between selecting your custom busy greeting and the system busy greeting.

You can select another user Manage Mailbox option.

You can select another Main Menu option.

Record Your Name

Your name is announced whenever you log onto your mailbox, the directory is accessed, the system greeting is selected, or when a message is sent by another voice mail user.

Your voice mail system prompts you through the entire recording sequence. You can re-record your name at any time simply by repeating these steps.

Notes

- Your voice mail system may not be configured to play your name when you log on to your mailbox.
- Your system may be programmed such that you need to record your extension as well as your name. Ask your System Administrator for the requirements of your system.

1. From the Manage Mailbox Menu, press 2 Change your User Options.	Your voice mail system prompts with Change your User Options Menu.
2. Press 6 Record your Name.	Your voice mail system prompts you to record your name.
3. At the tone, state your name slowly and clearly (and your extension, if required). Press # when done.	
4. (Optional) After recording, you can press: 1 Review recording 2 Re-record Press # when done.	Your newly recorded name (and extension) plays. You can re-record your name (and extension) as often as you wish.

Manage Mailbox

Change Your User Options

3 Append recording Press # when done.	You can add a short comment that plays at the end of the recording (for example, a vacation announcement).
4 Cancel recording	You can cancel your newly recorded name (and extension) and return to the previous menu.
9 Save recording	Your voice mail system confirms that your name (and extension) has been recorded and returns to the previous menu.

Change Your Message Notification

Your User ID can have up to 10 notification records programmed by the System Administrator with a specific notification method (message waiting lights, pagers, voice, etc.) and the time/day when that notification record applies. The repeat count (how many times the notification is attempted) and interval for retrying the notification is also set.

Once you have turned on the notification record numbers, your voice mail system automatically calls you at the designated number and with the chosen notification method.

Using the Change Message Notification option, you can enable/disable a notification method and/or change the notify phone number.

<ol style="list-style-type: none">1. From the Main Menu, press 3 <i>Manage Mailbox</i>.2. Press 2 <i>Change your User Options</i>.3. Press 7 <i>Change message Notification</i>.	Your voice mail system plays the Manage Mailbox options.
---	--

-
- | | |
|---|--|
| <p>4. Enter the notification template number (1~10).</p> <p>5. Press an option number:</p> <ul style="list-style-type: none">1 <i>Enable/disable notification template (toggle)</i>2 <i>Change notification digits. Enter the new notification telephone number's digits and press #.</i># <i>Save changes</i>9 <i>Return to previous menu</i> <p>6. Press 9 to return to the Manage Mailbox Menu</p> <p>...or 99 to return to the Main Menu.</p> | <p>Strategy confirms the template number, spells the template title, states whether the template is enabled or disabled, and tells you the phone number (if applicable).</p> <p>Note To select the correct notification template, you need to keep a written record of the template number and function for each template you will be changing.</p> <p>Pressing 1 toggles the notification template between Enable and Disable. After pressing 1, a prompt verifies the current status.</p> <p>Your voice mail system verifies the telephone number entered.</p> <p>Your voice mail system tells you that the notification template changes have been saved. Your voice mail system returns to the previous menu.</p> <p>Your voice mail system cancels the change message notification options and returns to the previous menu.</p> <p>You can select another user Manage Mailbox option.</p> <p>You can select another Main Menu option.</p> |
|---|--|

Manage Mailbox

Change Your User Options

Review Your Option Settings

1. From the Main Menu, press **3** *Manage Mailbox*.
2. Press **2** *Change your User Options*.
3. Press ***** to *Review your Option Settings*.
4. Press **9** to return to the Manage Mailbox Menu

...or **99** to return to the Main Menu.

Your voice mail system plays the Manage Mailbox options.

Your voice mail system verifies the status of your DND, Call Screening options and plays your selected busy message and name recording.

You can select another user Manage Mailbox option.

You can select another Main Menu option.

Manage Your Lists

Your voice mail system provides the ability to create and manage up to seven personal distribution lists. The lists consist of the User IDs to which you most frequently send messages.

At the time you create a list, you are given the option of recording a “list comment” that serves as a title or name for the list. The comment plays each time you use the list to confirm that you have chosen the correct distribution list.

From the Manage Your Lists Menu (shown below), you can review the list contents, add and delete User IDs to the list, and record a list comment to help you identify the list.

From the Main Menu:

3 **Manage Mailbox**

From the Manage Mailbox Menu:

3 **Manage your Lists**

Select **1~7** for a Personal List

1 **Review** your current list

2 **Add** a User ID to the list

3 **Delete** a User ID from the list

4 **Record** a list **Comment**

9 **Return** to previous menu

9 **Return** to previous menu

1. From the Main Menu, press **3** *Manage Mailbox*.
2. Press **3** *Manage your Lists*.
3. Select the desired list number **1~7**.

Your voice mail system plays the Manage Mailbox Menu.

You are prompted to enter an option.

Manage Mailbox

Manage Your Lists

4. After selecting a list, you can press:

1 *Review your current list*

The system prompts you with the name (and extension) of each User ID on the list.

2 *Add a User ID to the list*

Your voice mail system prompts you to enter the User ID.

Enter the User ID.
Press **#** when done.

The name (and extension) plays. You can add additional User IDs as needed.

3 *Delete a User ID from the list*

Your voice mail system prompts you to enter the User ID.

Enter the User ID.
Press **#** when done.

The name (and extension) plays. The system prompts "Deleted."

4 *Record a list Comment*

When sending a message, the comment plays each time the destination list is selected. Your voice mail system prompts you to record the comment.

Record your comment. Press **#** when done.

5. Press **9** to return to the previous menu

Your voice mail system returns to the previous menu.

...or **99** to return to the Manage Mailbox Menu

You can select another Manage Mailbox option.

...or **999** to return to the Main Menu.

You can select another Main Menu option.

Manage Guest User IDs

Guest User IDs provide limited access to the voice mail system for temporary and project-oriented employees, such as consultants and contractors. Guest users can only send messages to their Host User ID and other guests of their Host User ID.

The Guest User IDs are selected from a system-generated list and assigned on a per-use basis. See your System Administrator for details if you have this feature.

Managing Guest User IDs involves creating and deleting these IDs (menu shown below).

From the Main Menu:

- 3** Manage Mailbox

From the Manage Mailbox Menu:

- 4** Manage **Guest Mailboxes**
 - 1** Create a Guest Mailbox
 - 2** Delete a Guest Mailbox
 - 3** Review your Guest Mailboxes
 - 9** Return to previous menu

3498

1. From the Main Menu, press 3 Manage Mailbox.	Your voice mail system plays the Manage Mailbox Menu.
2. Press 4 Manage Guest User IDs.	Your voice mail system plays the Manage Guest User IDs Menu.
3. Select <i>one</i> of the following:	
1 Create a Guest User ID	The system prompts with a Guest User ID number. Be sure to make a note of the number and the person you assign.
2 Delete a Guest User ID	Your voice mail system prompts you to enter the User ID.
Enter the User ID. Press # when done.	The system confirms the Guest User ID is deleted.

Manage Mailbox

Use Guest User IDs

<ol style="list-style-type: none">3 Review your Guest User IDs4. Press 9 to return to the Manage Mailbox Menu...or 99 to return to the Main Menu.	<p>The system lists your Guest User ID numbers.</p> <p>You can select another user Manage Mailbox option.</p> <p>You can select another Main Menu option.</p>
---	---

Use Guest User IDs

Instruct your guest users to call the voice mail system and identify themselves as guest users of your mailbox. Only then can they use voice mail to send, receive, and reply to the messages with your mailbox (Host ID) as a typical voice mail user.

Note See “[Access Your Mailbox](#)” on [page 14](#) for more detailed instructions of the following steps.

<ol style="list-style-type: none">1. Call the voice mail system.2. Enter 998 + #.3. Enter the Host User ID + #.4. Enter * + the Guest User ID + #.5. Enter the security code + #.	<p>Note Check with your System Administrator for the User ID (default 998) configured for your system.</p> <p>The Host User ID’s greeting plays.</p> <p>Note Your voice mail system uses the combination of the Host User ID and the Guest User ID to identify the caller as your guest.</p>
--	---

This chapter covers the use of your voice mail with the Strata CIX40. Call Forward, Message Waiting, CIX Integration, Direct Transfer to Voice Mail, Voice Mail Conference features, and Call Monitor are all described.

Call Forward

Note See *Strata CIX DKT/IPT Telephone User Guide* for additional information on programming and using this feature on your phone.

There are two types of Call Forwarding: System and Station.

- System Call Forward (which is set in Programming) automatically directs calls to a predefined location, such as Voice Mail.
- Station Call Forward enables you to assign Call Forward destinations for each extension on your phone. Each extension can be independently set for a different Call Forward feature. You can set a flexible button to perform any Call Forward function.

Call Forward must be set prior to receiving the call.

Note Station Call Forward takes priority over System Call Forward.

[Table 1](#) on [page 66](#) contains the Call Forward Button sequences for performing Call Forward. There are two ways to perform each Call Forward function. One, enter the button sequence as described, or two, program a flexible button to perform the sequence.

► To use the Call Forward button sequence

- Follow the instructions in [Table 1](#) below shown under “Button Sequence.” Some features require additional input, such as:

Integration Features

Call Forward

- ◆ **Destination** – If the destination is an outside number, press **#** after entering the destination. The CIX accepts destination numbers of up to 32 digits.
- ◆ **Timer** – This is a two digit entry representing how long (8 to 160 seconds) your telephone should ring before forwarding the call. If you enter one digit, you must press **#** after entering the single digit.

Also, in the following table, (Tone) means that a confirmation tone plays at that point in the sequence.

Table 1 Call Forward Procedures

Feature	Button Sequence
Call Forward - Station Call Forward Any Call (Internal and Incoming Line)	
All Call	Press Extension button + #6011 (Tone) + Destination No. (Tone)
Busy	Press Extension button + #6021 (Tone) + Dest. No. (Tone)
No Answer	Press Extension button + #6031 (Tone) + Dest. No. (Tone) + Timer + #
Busy No Answer	Press Extension button + #6041 + Dest. No. + Timer + #
Cancel	Press Extension button + #6051 (Tone)
Call Forward - System Call Forward - Incoming Line Calls	
All Calls	Extension button + #6013 (Tone) + Dest. No. (Tone)
Busy	Extension button + #6023 (Tone) + Dest. No. (Tone)
No Answer	Extension button + #6033 + Dest. No. (Tone) + Timer (Tone) + #
Busy No Answer	Extension button + #6043 + Dest. No. (Tone) + Timer (Tone) + #
Cancel	Extension button + #6053 (Tone)
Call Forward - System	
Activate	#620 (Tone)
Cancel	#621 (Tone)

Message Waiting

Use your **Msg** LED/button and LCD to see/retrieve message(s).

An extension can receive up to four simultaneous Message Waiting indications and LCD messages. One message is reserved for the Message Center.

Your phone can be programmed to have up to four additional (flexible) Message Waiting buttons/LEDs. Ask if these buttons have been programmed on your phone. If so, substitute them when the **Msg** button/LED is mentioned in the following steps.

Responding to a Lit Msg LED

1. On an LCD phone, if you see a “+” press **Scroll** to display additional messages; otherwise, go to Step 2. The “+” indicates additional messages. The LCD can show up to three station messages for your extension and three for each additional (phantom) extension that you may have.
2. Press **Msg**, then lift the handset. Your phone rings the extension or voice mail device that sent the indication. The LED continues to flash red.
3. After answering the message(s), place the handset back on-hook.
4. If the Msg LED continues to flash, you have more messages; repeat Steps 1~3 above to retrieve them. Voice mail devices turn off the LED/LCD indications after a short delay, after you checked all messages.
5. To manually turn off your Msg LED, press your extension button, then press **#409**. Do this step for each message received.

Turning On/Off Message Waiting LED on Another Extension

If you call an extension and it's busy or there is no answer, you can light that extension's Message Waiting LED and enable that extension to call you back.

1. Dial an internal extension. You hear busy tone or there's no answer.
2. Press **Msg** or **7**. The Msg LED flashes red on the called phone. At your phone, the Msg LED lights steady red and the LCD shows the station number where you set a Message Waiting light.
3. Press **Spkr**. Your Msg LED turns Off. The Msg LED on the called telephone flashes until the called party presses the flashing **Msg** button - which calls you back.
4. To turn Off a Message LED that you have set on another extension, press **#64** plus the extension number that has the message light set. Then hang up to release your telephone.

CIX Integration

If your company's Toshiba Strata CIX phone system has the Proprietary Integration with your voice mail enabled, you have two additional features at your disposal—Soft Key Control of Voice Mail and Call Record to Voice Mail. If you cannot access these features, check with your System Administrator.

Soft Key Control of Voice Mail

If you have a Strata 3000-series digital phone equipped with a Liquid Crystal Display (LCD), many standard functions of the voice mail system can be displayed on the digital telephone LCD and operated by Soft Keys. Feature prompting makes voice mail functions easy to use via visual displays on the telephone in place of listening to voice prompts over the handset, although the voice prompts still play when soft keys are used.

Note For general information on using Soft Keys on your phone, please see the *Strata CIX DKT/IPT Telephone User Guide*.

When your telephone is idle, and a message arrives for an extension on your phone, the Msg LED is activated for the appropriate extension and updates the LCD with this display (shown right). If urgent messages are in the extension's mailbox, the SAVED display is replaced with the number of URGENT messages.

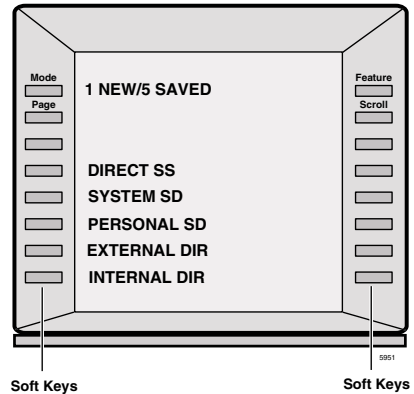

Once connected to your voice mailbox, the LCD displays the Main Menu options (shown at right). See [Table 2](#) on [page 70](#) below for a list of Main Menu soft keys.

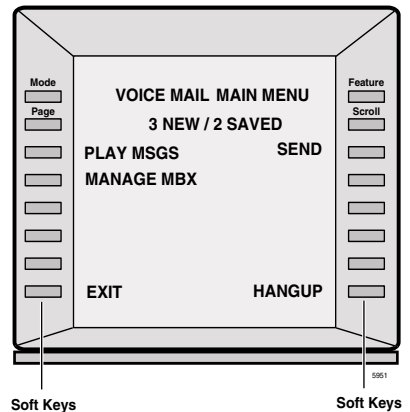

You are then able to perform many of the standard voice mail functions using the Soft Keys on your phone (Play Messages menu example shown at right). See [Table 3](#) on [page 70](#) for a list of Soft Keys.

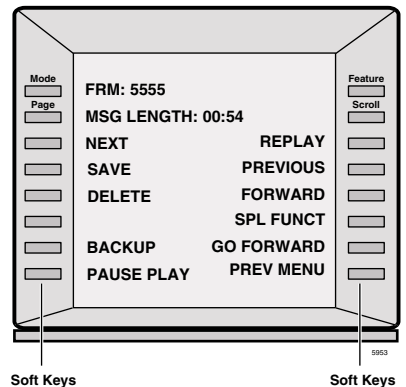

Integration Features

CIX Integration

Table 2 Voice Mail Main Menu Soft Keys for CIX Digital Telephones

DKT 3014 SDL	DKT 3007 SD DKT 3010 SD DKT 3020 SD IPT1020 SD	DKT 2010 SD DKT 2020 SD	Voice Mail Functions
PLAY MSGS	PLAY	PLAY	Play Messages
SEND	SEND	SEND	Send Messages
MANAGE MBX	MGMT	MGMT	Manage Mailbox
EXIT		EXIT	Exit Mailbox
HANGUP	QUIT	QUIT	Disconnect from GVPH

Table 3 Voice Mail Soft Keys for CIX Digital Telephones

DKT 3014 SDL	DKT 3007 SD DKT 3010 SD DKT 3020 SD IPT1020 SD	DKT 2010 SD DKT 2020 SD	Voice Mail Functions
ADD	ADD	ADD	Create a Guest Mailbox
ADD DESTS		ADD	Additional Destinations
ADD MBX	ADD	ADD	Add a mailbox to the list
AM	AM	AM	AM
APPEND	APPD	APPD	Append recording
BSY GRT REC		RECB	Record Busy Greeting
BUSY GREET		RGRT	Select Busy Greeting (toggle)
CALL SCREEN	SCRN	SCRN	Change Call Screening (On/Off)
CANCEL		CRTN	Cancel recording
CANCEL MSG	CANC	CANC	Cancel message and select new destination
CHANGE	CHNO	CHNO	Change notification digits
CHG GREETING	GRT	GRT	Change Greeting
CONT DELETE	CDEL	CDEL	Continuous Delete
CONT PLAY		CPLY	Continuous Play
DATE & TIME	DATE	DATE	Message Date and Time

Table 3 Voice Mail Soft Keys for CIX Digital Telephones *(continued)*

DKT 3014 SDL	DKT 3007 SD DKT 3010 SD DKT 3020 SD IPT1020 SD	DKT 2010 SD DKT 2020 SD	Voice Mail Functions
DELETE	DEL	DEL	Delete the message/guest mailbox
DELETE MBX	DEL	DEL	Delete a mailbox from the personal distribution list
DELETE MSG	DMSG	DMSG	Delete message (Future Delivery Review)
DIRECTORY	DIR	DIR	Directory plus name
DND	DND	DND	Change Do Not Disturb (On/Off)
ENABLE	EDNO	EDNO	Enable/Disable: <ul style="list-style-type: none"> • Notification template (toggle) • Automatic copy
FORWARD	FWD	FWD	Forward the current message
FUTURE DLVR		FUTR	Set Future Delivery, Future Delivery Review
GO FORWARD			Go forward (advance)
GUEST MBXES		GST	Manage Guest Mailboxes
MARK PRIVAT	PRV	PRV	Set Private status (On/Off)
MARK URGENT	URG	URG	Set Urgent status (On/Off)
MSG NOTIFY		NOTE	Change message Notification
MULTI ENTRY	MULT	MULT	Multiple Destinations
NAME RECORD		NAME	Record your Name
NEXT	NEXT	NEXT	Play next message
NEXT MSG	NMSG	NMSG	Play next message (Future Delivery Review)
NO	NO	NO	Continuous Delete
PAUSE	PAUS	PAUS	Pause recording
PER DST LST	LIST	LIST	Manage Personal Distribution Lists
PERSNL LIST	LIST	LIST	Personal distribution list (1~7)
PM	PM	PM	PM

Integration Features

CIX Integration

Table 3 Voice Mail Soft Keys for CIX Digital Telephones *(continued)*

DKT 3014 SDL	DKT 3007 SD DKT 3010 SD DKT 3020 SD IPT1020 SD	DKT 2010 SD DKT 2020 SD	Voice Mail Functions
PREVIOUS		PREV	Play the Previous message
PREV MENU	PREV	MENU/PREV	Return to previous menu
REC COMMENT	COMM	COMM	Record a list Comment
RECORD	REC	REC	Record
REPLAY		RMSG	Replay current message
REPLY	REPL	REPL	Reply to the current message
RE RECORD	RREC	RREC	Re-record
RETRN RECPT	RTRC	RTRC	Set Return Receipt request (On/Off)
REVIEW	REWV	REWV	Review recording/guest mailboxes
REVIEW LIST	REWV	REWV	Review current list
REV OPTIONS		ROPT	Review Option Settings
SAVE	SAVE	SAVE	Save the message/recording/changes
SAVE MSG	SMSG	SMSG	Save message (Future Delivery Review)
SECURTY COD	CODE	CODE	Change Security Code
SEND MSG	SEND	SEND	Send and Return to Main menu
SET DAY	DAY	DAY	Set the Day (1~31)
SET HOUR	HOUR	HOUR	Set the Hour (1~12)
SET MINUTES	MIN	MIN	Set the Minutes (0~59)
SET MONTH	MTH	MTH	Set up Month (1~12)
SET YEAR	YEAR	YEAR	Set up Year (last two digits)
SPCL FUNCT	SPCL	SPCL	Special Functions
SPECIAL SEND	SPCL	SPCL	Special Delivery Options
STOP	STOP	STOP	End recording
USER OPTNS	OPTN	OPTN	Change User Options
YES	YES	YES	Continuous Delete

Call Record to Voice Mail

While on an active call, a station user can record the conversation and store it in a voice mailbox. Recordings can also be paused or restarted. Depending upon your System Administrator, you are given either a manual method of recording that allows you to designate the mailbox where the recording will be sent or an auto method that automatically sends the recording to a predefined mailbox that is assigned to the phone you are using. This may be your personal mailbox.

Note Ask your System Administrator which method you need to use when recording a call.

This feature requires the presence of a **Record** and a **PS/RES** (Pause/Resume) button on your telephone. Feature codes are not available.

Important! *Voice mailboxes have a definable limit on the length one message can be. If you plan on doing lengthy recordings using this feature, see your System Administrator so your message recording time can be properly defined.*

► To record a call

1. With a call in progress, press **Record**.

If you are using the *auto method*, the Record LED flashes rapidly and there is approximately a one second interval (in extreme busy conditions, up to five seconds) before the recording starts and the Record LED changes to the in-use interval flash rate. You are now recording. Continue to Step 3.

...or if you are using the *manual method*, the Record LED flashes green rapidly. Continue to Step 2.

2. (Manual method only) If you want to record the call to the predefined mailbox associated with the phone you are using, press **#**. The Record LED flashes rapidly and there is approximately a one second interval (in extreme busy conditions, up to five seconds) before the recording starts and the Record LED changes to the in-use interval flash rate. You are now recording.

...or if you want to record this call to another mailbox, enter the mailbox number (usually the extension number). Finish by pressing **#**. The Record LED flashes rapidly and there is approximately a one second interval (in extreme busy conditions, up to five seconds) before the recording starts and the Record LED changes to the in-use interval flash rate. You are now recording.

Integration Features

Direct Transfer to Voice Mailbox

3. To stop recording, press **Record**. The LED turns off and the recording stops. To resume recording at this point, you need to begin a new recording, see Step 1 on previous page.

Pause/Resume Recording

You can pause the recording while continuing the conversation by pressing **PS/RES**. The PS/RES LED flashes red. Your conversation is no longer being recorded.

To resume recording as part of the same message, press the **PS/RES** button again. You can pause and resume indefinitely throughout the conversation. The only limit may be a message length imposed by the voice mail system.

Direct Transfer to Voice Mailbox

An internal user on the Strata CIX can transfer a call directly to another person's voice mailbox without waiting for the call to forward from the called party's telephone. The voice mailbox does not even need to be associated with an active telephone in the Strata CIX.

Direct Transfer to Voice Mail simplifies getting a call for a busy or absent employee to his/her mailbox. It eliminates the need for the caller to enter the desired mailbox number after being connected to the voice mail system.

► To transfer a call directly to Voice Mail (VM)

1. While on a call, press **Cnf/Trn**. You hear feature dial tone.
2. Press **Direct Transfer to VM** or enter **#407**. You hear entry tone.
3. Enter the VM mailbox number (usually the same as the extension number), then press **#**. The call transfers immediately and your extension becomes idle. The transferred party hears the greeting associated with the specified mailbox and can then leave a message.

Note See *Strata CIX DKT/IPT Telephone User Guide* for information on programming this feature on your phone.

Voice Mail Conference

Voice Mail ports may be included in conference calls. This enables all members of the conference to listen to and play voice mail messages.

Call Monitor

Using the flexible **Call Monitor** button on your telephone, you can listen to the message a caller is recording in your voice mailbox. You can also answer the call and talk to the caller anytime during the message recording.

► To enable Call Monitor on your telephone

1. While on hook, press the idle **Call Monitor** button. The button's LED flashes red.
2. Enter your voice mail password (maximum of 16 digits; numbers 0~9).
3. Press **#**. The password displays with *****. The LCD now displays "Call Monitor Enabled" briefly and then displays the original information. The Call Monitor LED turns solid red indicating that the feature is enabled.

► To disable Call Monitor on your telephone

- With the Call Monitor LED solid red, press **Call Monitor**. The Call Monitor LED turns off.

► To monitor a call using Call Monitor

A flashing red Call Monitor LED indicates that a message is being recorded in voice mail.

- Using the speakerphone or handset, press **Call Monitor**. The Call Monitor LED lights green. You can hear the caller leaving the message, but the caller cannot hear you. The LCD displays "Monitoring Voice Mail."

► To answer the call during the message recording

- To talk to the caller during the recording, press **Call Monitor**. The recording stops and the LED turns solid red. The LCD display indicates the extension or line to which you are connected.

This page is intentionally left blank.

Glossary

This glossary defines frequently-used voice processing system features and functions.

Term	Definition
Busy Greeting	You can select your custom busy or the system busy greeting for callers to hear when your telephone is busy. If you do not record your custom busy greeting, the system busy greeting automatically plays.
Call Record	You can record a live call into your mailbox from your Strata CIX telephone.
Call Screening	Call Screening operates in on/off mode. When on, your voice mail system asks callers for their name and company. Without the caller's knowledge, the system relays that information to you. You can decide to receive the call, let the call forward to your mailbox, or transfer the call to another extension with or without announcement.
Caller	Someone who calls into the voice mail system. A caller can obtain information, leave a message for someone, and/or provide information.
Called Party	The telephone user the caller reached. See "User."

Glossary

Directory ~ New Message Queue

Term	Definition
Directory	A caller enters digits corresponding to the first few letters of a user's name and your voice mail system plays the recorded name (and optionally extension) that matches the entered digits. Your voice mail system offers the caller the option of selecting the name and being transferred or hearing the next name.
Do Not Disturb (DND)	Do Not Disturb operates in on/off mode. When on, your voice mail system automatically sends calls to your User ID (mailbox) without ringing your telephone first.
DTMF	Dual Tone Multi-frequency.
FIFO (First In, First Out)	Messages play in either FIFO or LIFO order. FIFO plays messages from oldest to newest.
Future Delivery	With future delivery, you can arrange for your message to be delivered at a specific time and date in the future. Once you send the message, you can use the Play Messages—Future Delivery Review option to review, continue to send, or delete the message.
Guest User ID	Guest User IDs provide limited access to the voice mail system for temporary and project-oriented employees, such as consultants and contractors. Guest users can only send messages to their Host User ID and other guests of their Host User ID.
LIFO (Last In, First Out)	Messages play in either LIFO or FIFO order. LIFO plays messages from newest to oldest.
Mailbox (User ID)	See User ID.
Name Recording	Your name (and optionally, extension) recording is used for the directory, system greeting, and User ID.
New Message Queue	There are two message queues: new and saved. The new message queue contains unheard and partially heard messages. When playing new messages, urgent messages always play first.

Term	Definition
Personal Greetings	<p>You may record up to seven personal greetings that are played for callers when you are unavailable. Although only one greeting can be in effect at any one time, you can switch between the greetings by entering the greeting number, or pre-schedule different greetings to play at a certain time and/or day.</p> <p>Greetings can be reviewed or re-recorded. You can also select the default system greeting.</p>
Personal List	<p>You can create/modify up to seven personal destination (distribution) lists of User IDs and record a list comment for identification. When sending messages, you can select a User ID, personal list, system list, and/or the directory as the destination.</p>
Private Messages	<p>You can mark a message “private,” meaning the message cannot be forwarded by the recipient to another user. The recipient is told the message has the Private attribute set when listening to his/her messages.</p>
Return Receipt	<p>When sending, forwarding, or replying to a message, you can request a return receipt. Your voice mail system notifies you when and by whom the message was received. The recipient is not notified that receipt verification was requested and cannot circumvent the procedure.</p>
Saved Message Queue	<p>There are two message queues: new and saved. The saved message queue contains messages that you saved or that were automatically saved by the system. Messages flagged to be saved are moved to the saved message queue after you have logged out of your mailbox.</p>
Security Code	<p>Each User ID in the system has a security code. You must enter your security code to access your mailbox. The security code ensures the privacy of your messages, personal greetings, etc.</p>
System Administrator	<p>The representative in your company responsible for configuring the voice mail system and your mailbox to suit you and your companies needs.</p>
System Greeting	<p>Pre-recorded greeting that adds your recorded name (and extension, if required): “Please leave a message for (name).” Can be used by any user on the voice mail system. Based on your selection, callers hear the system greeting or a personal greeting.</p>

Glossary

System List ~ User Notification

Term	Definition
System List	Destination (distribution) list of User IDs created and maintained by the System Administrator. Any user on the voice mail system can use the list. When sending messages, you can choose a User ID, personal list, system list, and/or the directory as the destination.
Tone-dialing Telephone	DTMF push-button tone dialing telephone.
Urgent Messages	Messages are marked Urgent by the sender and by default, are played first, followed by all other messages. The System Administrator can set a notification record to use pager notification exclusively whenever Urgent messages are received.
User	Subscriber of the mailbox, also known as a mailbox user. A user has access to one or more User IDs in the system by knowing the security codes. Once a user accesses his/her User ID, he/she can play back messages, delete those messages, send them to other User IDs, etc.
User ID/User ID Mailboxes	Number for the mailbox user, also known as a voice mailbox. A user mailbox records messages from callers. A user periodically checks the mailbox for messages, etc., or a variety of automatic notification methods can be employed. There is generally one mailbox for each extension, although several mailboxes can share a single extension when multiple users share the same telephone line.
User Notification	Each User ID can have up to 10 notification records set by the System Administrator to automatically call and notify you of messages. You can enable/disable the notify method for each of these records or change the notification telephone number.

Index

A

- about this guide
 - conventions 8
 - organization 7
 - related documents/media 9
- access your mailbox 14

B

- basic functions
 - delete 25
 - forward 26
 - play 25
 - replay current message 26
 - reply 26
 - save 25
- busy greeting 7
 - record 55
 - select 56
- buttons
 - extension 8

C

- call forward
 - system 65
- call monitor button 75

- call record 73
- call screening 53
- change
 - security code 19
 - your greeting 46
 - your user options 51
- continuous
 - delete 28
 - play 28
- CTX Integration 68

D

- destination
 - additional users 36, 39, 41
 - directory 10, 34, 37, 41
 - multiple destinations 35
 - personal list 9, 35, 38, 42
 - system list 10, 35, 38, 42
 - user ID 34, 37, 41
- direct transfer to voice mailbox 74
- directory 34, 37, 41
- distribution lists 9, 10
- do not disturb 52

E

- exit mailbox 20

extension number 8

F

FIFO 5

forward message 6, 26, 37

future delivery 8

review 27

setting 44

G

getting started 13

greeting

busy 7, 55, 56

change 46

personal 7

change your selection 49

create 47

record over 47

review greeting 50

sample 18, 47

system 7

guest user IDs

manage 63

use 64

L

LIFO 5

lists

manage 61

personal distribution 35, 38, 42

system distribution 35, 38, 42

M

mailbox

access 14

exit 20

manage options 45

personalize 4

security code 19

manage

guest user IDs 63

lists 61

mailbox 45

menu

change your user options 51

greeting 46

main 3

manage mailbox 45

play messages 24

send messages 33

message waiting 67

message waiting light

on 68

on another telephone 68

messages

additional destinations 36, 39, 41

append 36

continuous delete 28

continuous play 28

control

back up (rewind) 23

go forward (advance) 23

pause/resume 23, 38, 40

play next 23

play previous 23

volume 23

date and time 27

destination 9

forward 6, 26, 37

future delivery 8, 27, 44

- new message queue 4, 28
- notification 58
- play 21
- private 8, 43
- queues 4
- reply 6, 26, 40
- re-record 35
- return receipt request 8, 43
- review recording 35
- saved message queue 5, 28
- send 31
- special delivery options 8
- types 6
- urgent 8, 43

Msg button/LED 67

multiple destinations 35

N

- name
 - recording 17
- new/saved messages 4, 28
- notification 58

P

- pause/resume playback 23, 25, 38, 40
- pause/resume recording 32, 35
- personal
 - distribution list 35, 38, 42
 - greeting 7
 - change your selection 49
 - create 47
 - record over 47
- play messages 21, 24
 - special functions 27
- playback

- back up (rewind) 23
- continuous delete 28
- continuous play 28
- go forward (advance) 23
- next message 23
- pause/resume 23, 25, 38, 40
- previous message 23
- replay 26
- volume 23

playback controls 22

private messages 8, 43

Q

- queues 4, 28

R

- record
 - busy greeting 55
 - controls 31
 - messages
 - append
 - comment 39
 - recording 36
 - reply 41
 - re-record
 - comment 39
 - message 35
 - reply 41
 - review
 - comment 38
 - recording 35
 - reply 40
 - name 17
 - pause/resume 32, 35
- record to voice mail 73

- reply message 6, 26, 40
 - additional users 41
 - set future delivery 44
 - special functions 43
- return receipt request 8, 43

S

- security code 13
 - change 19
- send messages 31
- soft keys 68
- special delivery options
 - private 43
 - return receipt request 43
 - urgent 43
- special functions 27, 43
 - continuous delete 28
 - continuous play 28
 - date/time 27
 - future delivery review 27
 - new/saved queue 28
- Strata 3000/2000-series digital phones 68
- Strata CTX 68
- system
 - distribution list 35, 38, 42
 - greeting 7

T

- tutorial 13
 - user 11

U

- urgent messages 8, 43
- user ID 15, 34, 37, 41
- user options

- busy greeting 11, 55
- busy greeting selection 56
- call screening 10, 53
- change 51
- do not disturb 10, 52
- message notification selection 11, 58

- user prompts 11
- user tutorial 11, 13

V

- voice mail conference 74
- volume control 23, 25